

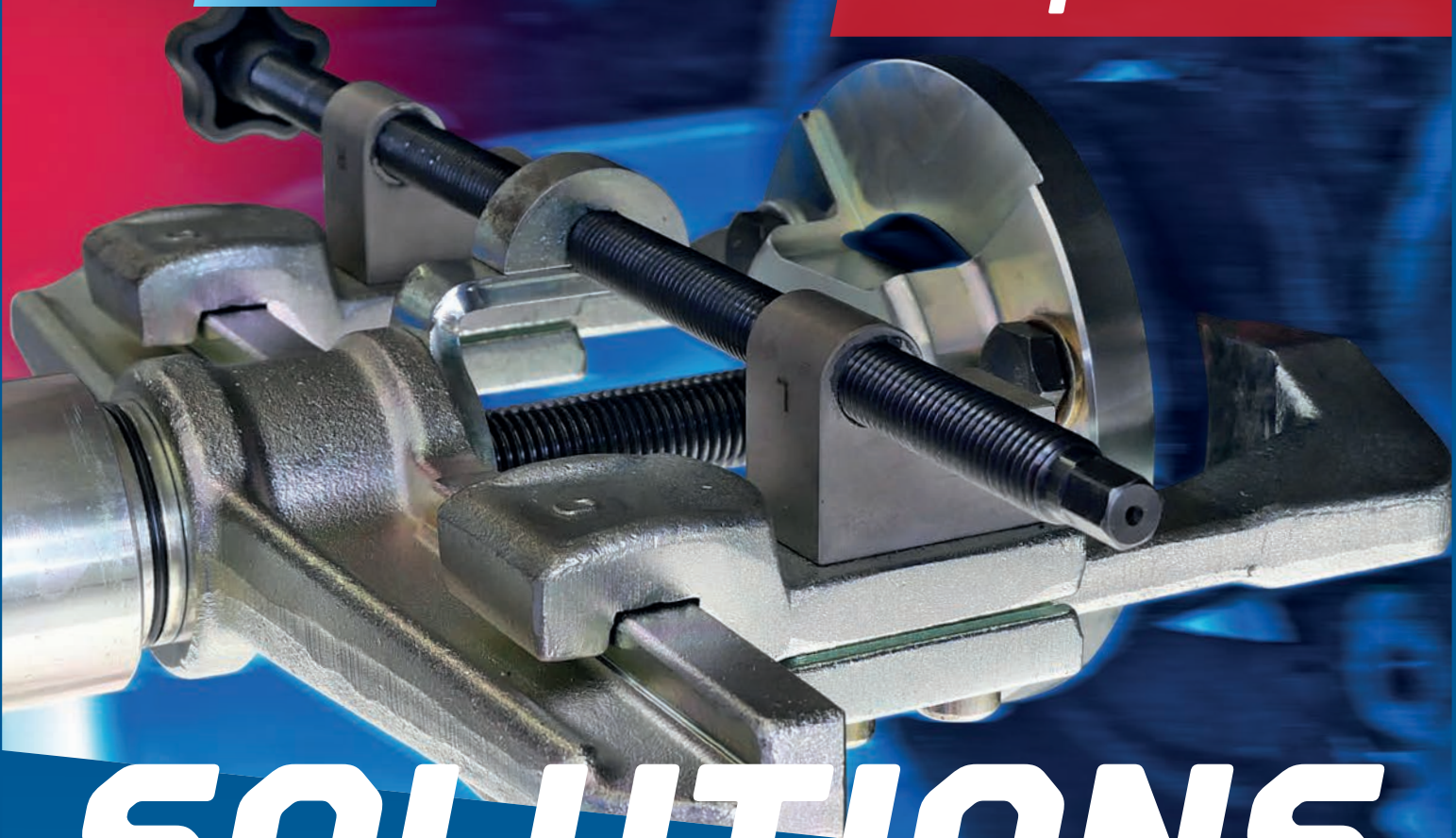

Videoscopes
from page 2

NEW

105
Top deals



SOLUTIONS

NEWS + PROMOTION 01.04.2023 - 30.09.2023

MISSION: KLANN POSSIBLE

Time saving, safe, well thought out tools.

OPERATION BOARD

Made in Germany



TIME SAVING

These tools especially save time and thus real money.



SAFE WORK

With these tools, the focus is particularly on safety during use



ONLY FROM GEDORE

These tools are protected by us by patent, utility model, or design patent



MATERIAL-PROTECTING

These tools protect vehicle of spare parts from damage during removal and installation



COMMERCIAL VEHICLES

These tools are especially developed and suited for the use on commercial vehicles



TRANSPORTERS

These tools are especially developed and suited for the use on transporters



PASSENGER CARS

These tools are especially designed and suitable for use on passenger cars

KL-0870-10 K / KL-0880-10 K VIDEOSCOPE

NEW

KL-0870-10 K

CLEANING VIDEOSCOPE

Cleaning the air conditioner evaporator is usually done blind. Cleaning agent is sprayed into the ventilation shaft without knowing whether the affected areas have been reached precisely. With the help of the video endoscope with cleaning function **KL-0870-10 K**, cleaning can be carried out very precisely, saving time and money. The cleaning nozzle and the camera are mounted at a 90° angle to the cable/hose. This enables you to clean even hard-to-reach places. The small lens with LED illumination delivers high-resolution images to the 3.5" LCD display. Images and videos can be saved with date and time stamp to provide the customer with detailed documentation. With this tool, the cleaning of the air conditioning evaporator is carried out extremely precisely and economically, thus saving time and money.



NEW



KL-0880-10 K **MICRO VIDEOSCOPE**

Damage analysis on engines, transmissions, exhaust systems, etc. is always a difficult undertaking. In most cases, many add-on parts have to be dismantled or the component to be inspected has to be disassembled in order to carry out a meaningful visual inspection. This is very time-consuming and costly, just to find out whether there is any damage at all, and if so, what kind. This can be avoided with the **KL-0880-10 K** video endoscope from Gedore Automotive. Due to its extremely small lens and a swivel range of over 360°, you can get to any part of the component to be inspected with only minor disassembly work. Thanks to the 3-stage LED illumination, everything can be optimally illuminated. The videoscope is able to provide the images and videos with date and time stamp in order to offer the customer a detailed documentation of the damage analysis. The live images and recordings are displayed via a high-resolution HD colour display. Alternatively, it is possible to connect a smartphone or tablet to the device. The recordings are simply transferred to any computer via USB. This robust and at the same time very delicate tool saves a lot of time and money when troubleshooting.



KL-0870-10 K

CLEANING VIDEOSCOPE



Universally applicable on cars, vans, commercial vehicles, buses, construction machinery, agricultural machinery.

- Enables the localisation and targeted removal of contamination.
- The transversely mounted camera with LED illumination and cleaning nozzle reaches even hard-to-reach places, e.g. the evaporator of the air-conditioning system.
- Slim camera unit Ø15x23 mm with powerful cleaning nozzle
- Dust- and water-proof lens with adjustable LED illumination
- For standard compressed air connection with 6 - 8 bar
- 250 ml container for cleaning fluids
- Live viewing via 3.5" colour display with zoom, rotate and mirror function
- Photo and video documentation with date/time stamp
- Incl. 8 GB microSD card and powerful 3.7 V lithium-polymer battery (1650mAh)
- Direct playback of photos and videos on the display

NEW

4parts

Code	No.	Display	Resolution	Cable diameter (max.)	Length, cable	Filling quantity	View angle	Operating pressure
3444929	KL-0870-10 K	3.5"	1280 x 720	23 mm	80 cm	250 ml	80°	6 - 8 bar

KL-0880-10 K

MICRO VIDEOSCOPE

Ø 3.9 mm



Universally applicable on cars, vans, commercial vehicles, buses, construction machinery, agricultural machinery.

- Enables quick and easy inspection of extremely difficult-to-access components
- For professional damage analysis on engines, transmissions, intake systems, etc.
- Extremely slim Ø 3.9 mm micro camera with 1280x720 pixels
- Dust- and water-proof lens with adjustable LED illumination
- ±180° swivel angle due to 2-way joint
- Live viewing via 5.0" HD colour display with zoom, rotate and mirror function
- Photo and video documentation with date and time stamp
- Incl. 8 GB microSD card and powerful 3.7 V lithium-polymer battery (5000 mAh)
- Connection with smartphone, tablet and laptop etc. possible
- Direct playback of photos and videos on the display

NEW

8parts

Code	No.	Display	Resolution	Swivel angle	Cable diameter (max.)	Length, cable	Number of LEDs	Battery	Temperature range
3444910	KL-0880-10 K	5.0"	1280 x 720	+/- 180°	3.9 mm	1 m	6	5.000 mAh	-10 up to +60 °C

KL-0080-11 K

REPAIR KIT

for FAKRA plug connections



Universal fit for cars, commercial vehicles, and vans with FAKRA cable/plug connections (RTK031 and RG174). Installed, for example, on GSM mobile radio antennas, GPS antennas, and in rear-view camera systems.

For quick and professional stripping, crimping, and repairing FAKRA cable/plug connections. Time-consuming replacement of the entire FAKRA coaxial cable, usually across the vehicle, is not required! Defective, oxidised, or provisionally repaired FAKRA cable/plug connections can lead to system failures on GSM mobile radios, GPS systems, and rear view camera systems.



68 parts

Code	No.	Cable diameter (RTK031)	Cable diameter (RG174)	Crimping inserts	Stripping inserts	Quantity per connector housing	Quantity per contact
3424634	KL-0080-11 K	3.2 mm	2.8 mm	2	2	5	10

KL-0080-12 K

CRIMPING TOOL KIT

StreetScooter



NEW



Fits universally for "Micro 64" cable/plug connections.

- Installed in StreetScooter.
- For professional maintenance of cable/plug connections
- For damage-free release from the connector housing
- Perfect crimping results as ex works
- Crimping process must be completely executed in order to open the pliers again

54 parts

Code	No.	for connector systems	Crimping inserts	Unlocking inserts	Quantity per contact	Storage
3426416	KL-0080-12 K	Micro 64 (0,35-0,8 mm ²)	1	1	25	in case

KL-0080-1 K
**WIRING HARNESS
 REPAIR KIT**
 with consumables



Application video



1047 parts

Universally suitable for standard wire/terminal connections on passenger cars, commercial vehicles, vans, buses, construction machinery, agricultural machinery, trailers, and semi-trailers.

Especially for wire/terminal connections with and without single conductor seal (ELA), such as MCP-2.8, JPT, MQS, DTM/DT-twisted, SuperSeal-1.5, as well as for conventional crimp connections such as wire lugs, flat spade wire terminals, female flat spade wire terminals, butt connectors, etc.

UNLOCKING, STRIPPING and **CRIMPING**, all stored within easy reach in a clearly arranged case system.

Defective, oxidised, or provisionally repaired wire/terminal connections can lead to serious system failures on the vehicle. For this purpose, the repair kit for professionals in particular offers a comprehensive and robust assortment for the quick and professional repair of almost all common wire/terminal connections on the vehicle. Due to the unique and compact basic tool/changeable insert system, this can also be expanded as required in the future. The scope of delivery already includes a generous assortment of the most common contacts and seals.

UNLOCKING: Unlocking tool with matching interchangeable inserts for a damage-free release of a wide variety of cable/plug connections from the connector housing.

STRIPPING: Stripping tool with razor-sharp interchangeable inserts for precise stripping, especially for cables with extremely slippery PVC isolation.

CRIMPING: Crimping tool with interchangeable inserts for a perfect crimping result as ex works, guaranteed by the special cable / plug positioners. The tool can only be opened again when the pressure required for the crimping process has been fully applied.

Code	No.	for connector systems	Unlocking inserts	Stripping inserts	Crimping inserts	Quantity per contact
3429814	KL-0080-1 K	DTM/DT twisted (0.5-2.1 mm ²) JPT (0.2-2.5 mm ²) MCP-2.8 (0.2-1.0 mm ²) MQS (0.08-0.75 mm ²) SuperSeal-1.5 (0.35-2.5 mm ²)	7 pcs	2 pairs	11 pcs	25 pcs



KL-0080-123

SUPPLEMENTARY KIT MICRO 64

Made in Germany



Fits universally for "Micro 64" cable/plug connections (0.35- 0.8 mm²).

- Installed in StreetScooter
- In combination with KL-0080-1 K / -10 K

NEW

52parts

Code	No.	for connector systems
3448169	KL-0080-123	Micro 64 (0,35-0,8 mm ²)

KL-0080-130

SUPPLEMENTARY KIT MICROTIMER

Made in Germany



Fits universally for „MicroTimer 2/3“ cable/plug connections (0.2- 1.0 mm²).

- In combination with KL-0080-1 K / -10 K
- For connection with and without single conductor seal (ELA)

NEW

278parts

Code	No.	for connector systems
3448320	KL-0080-130	MicroTimer 2/3 (0.2-1.0 mm ²)

KL-0080-131

SUPPLEMENTARY KIT MCP 1.5K

Made in Germany



Fits universally for „MCP 1.5K“ cable/plug connections (0.2- 1.5 mm²).

- In combination with KL-0080-1 K / -10 K
- For connection with and without single conductor seal (ELA)

NEW

203parts

Code	No.	for connector systems
3448460	KL-0080-131	MCP 1.5K (0.2-1.5 mm ²)

KL-0080-104 K

CONTACT ASSORTMENT

in case

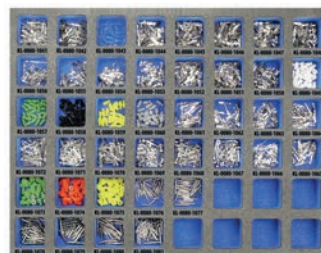
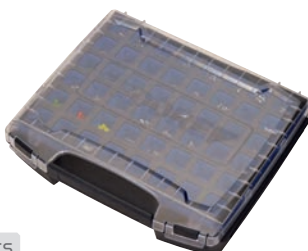

Universally suitable for common cable/plug connections on vehicles and trailers.

- Extensive assortment of the most common connectors and sealings

1025parts

Code	No.	Text	Quantity per contact	Storage
3422984	KL-0080-104 K	DTM/DT twisted (0.5-2.1 mm ²), JPT (0.2-2.5 mm ²), MCP-2.8 (0.2-1.0 mm ²), MQS (0.08-0.75 mm ²), SuperSeal-1.5 (0.35-2.5 mm ²)	25 pcs	in case

Made in Germany



KL-4600-200

TOOL TROLLEY WITH HIGH-VOLTAGE ASSORTMENT (103 PARTS)

- The perfect tool kit for maintenance and repairs on hybrid and electric vehicles
- Suitable for vehicles of all manufacturers
- All tools are protective insulated to EN 60900/EC 60900
- Tool trolley: Side walls with Euro perforation, externally mounted heavy-duty chassis, ball-bearing guide rails and central lock
- Included: digital voltage tester, 3/8" VDE torque wrench Safety lock, socket spanner and ratchet in 3/8" and 1/2", and many more.

Content:

- 3/8" VDE-tool assortment with SW 6 - 22; XZN M8 - M12
- 3/8" VDE torque wrench 5 - 25 Nm
- 1/2" VDE workshop assortment with SW 10 - 24; IN 5 - 8 mm;
- VDE single open-end spanner SW 9 - 24
- VDE single end ring spanner SW 8 - 22
- VDE slotted and cross-head screwdriver; TX T8 - T30
- VDE cable shear, VDE universal pliers, VDE power combination pliers, VDE power diagonal cutter, VDE flat nose-round pliers, angled, VDE flat pliers, VDE cable stripping knife
- Meter connection fittings
- Digital voltage tester 1,000 V
- Electrician's protective gloves
- Undergloves
- Rubberised cloth cover 250 x 350 mm
- ISO insulation mat
- Barrier tape
- Warning sign "Flash"
- Warning sign high voltage "Switched ON", Warning sign "Switched OFF"
- Safety padlock
- Plastic clamp 80 mm and 160 mm
- Cable splitting wedge
- Rubber hammer

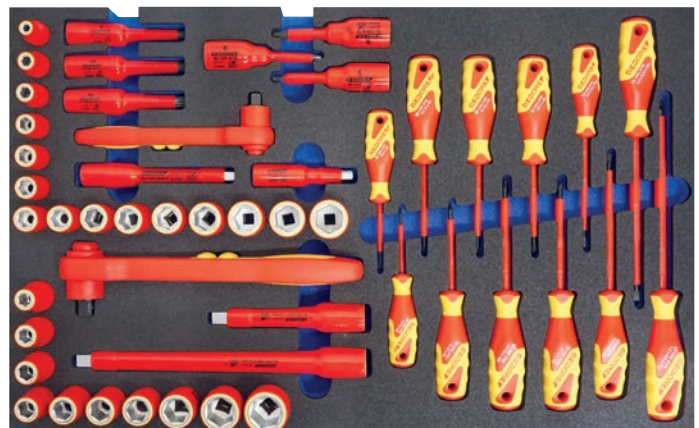

103 parts 3/8" 1/2" VDE GS 1000V

Code	No.	Dimensions	Number of drawers	Load capacity (mobile/static)	Load capacity (per drawer)	Design
3415740	KL-4600-200	H 985 x W 775 x D 475 mm	6	650 kg / 900 kg	40 kg	3/8" + 1/2"

KL-4600-10 Z

**VDE HYBRID TOOL
INCL. SUPPLEMENT**

Made in Germany



**Complete package
at a special price**



Fits universally for hybrid and electric vehicles.

- Perfect tool kit for maintenance and repairs on hybrid and electric vehicles
- Suitable for vehicles of all manufacturers
- All tools are protective insulated to EN 60900/EC 60900
- With digital HV voltage tester and safety padlock
- Incl. empty compartment or VDE torque wrench 4508-02/-05

Content:

- 3/8" VDE socket spanner no. VDE 30, SW 6 8 9 10 11 12 13 14 15 16 17 18 19 20 22 mm
- 3/8" VDE screwdriver bit no. VDE INX 30, SW 8 10 12 mm
- 3/8" VDE extension no. VDE 3090 -3 -6, 75 150 mm
- 3/8" VDE reversible ratchet no. VDE 3093 U
- VDE slotted screwdriver no. VDE 2170, 2.5 3.5 4 5.5 mm
- VDE cross-head screwdriver no. VDE 2160 PH 1 2 3
- VDE screwdriver TX no. VDE 2163 TX T20 T25 T30
- VDE cable shear no. VDE 8094, 200 mm
- VDE universal pliers fitting no. VDE 146 10, 10"
- VDE power combination pliers no. VDE 8250-200 H, 200 mm 2K-handle
- VDE power diagonal cutter no. VDE 8314-180 H, 180 mm
- VDE flat nose-round pliers no. VDE 8132 AB-200 JC, 200 mm angled 2K handle
- VDE flat pliers no. VDE 8120-160 H, 160 mm 2K handle
- VDE cable stripping knife no. VDE 4522, 180 mm
- Meter connection fitting no. V 914, size 1 2 3
- Digital voltage tester 1,000 V
- Electrician's protective gloves
- Undergloves
- Rubberised cloth cover 250 x 350
- ISO insulation mat
- Barrier tape
- Warning sign "Flash"
- Warning sign High voltage "Switched on"
- Warning sign High voltage "Switched off"
- Safety padlock

Code	No.	Consisting of	Design
3418642	KL-4600-10 Z	KL-4600-100 K VDE supplementary kit and 1100-1094 VDE HYBRID tool kit	3/8"

KL-0190-13

COMPACT UNLOCKING TOOL

Made in Germany

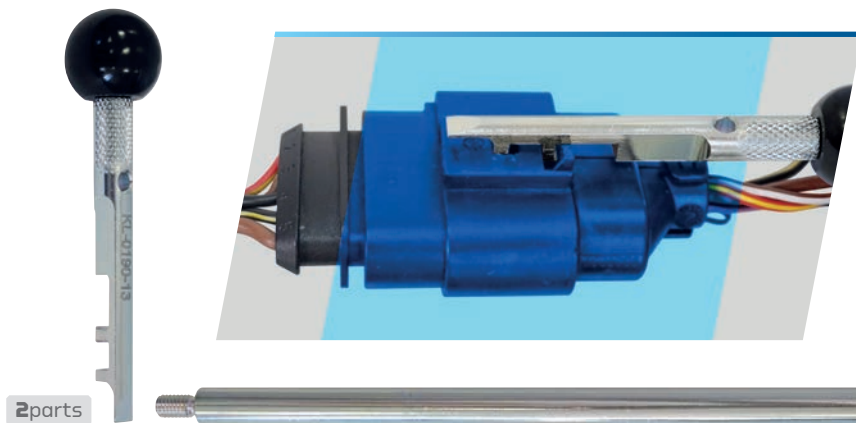

Universally suitable for a wide range of cable connector systems.

- For professional and non-destructive unlocking of cable plugs
- Enables cable plugs to be unlocked from both sides (pulling or pushing)
- The cable connector can be unlocked even if the cable connector has broken off
- Very compact design

Code	No.	Length without extension	Length with extension
3408175	KL-0190-13	85 mm	345 mm

KL-0029-200 K

REMOVAL AND INSTALLATION TOOLS FOR MCPHERSON SUSPENSION STRUTS



Suitable for McPherson suspension struts in combination with the vehicle-specific supplementary kits.

TIME, COST-SAVING and EFFICIENT, simply HELPFUL!

- Unique special device for compressing or reducing the overall length of the suspension strut
- Enables an extremely quick removal and installation of McPherson suspension struts, particularly for vehicle axles with suspension strut clamping holes
- Extremely high time and cost savings, as there is no need to loosen axle parts and no wheel alignment is required
- Spring shape and spring pitch are completely irrelevant here
- No intervention in the spring necessary
- Maximum user safety
- Simplest handling
- High load capacity
- 4-fold safety

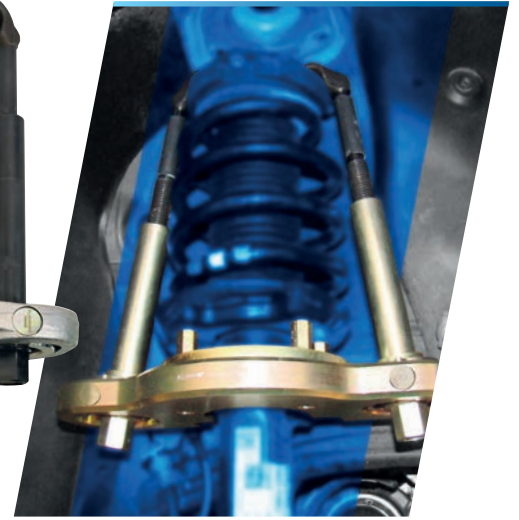

Necessary accessories:
Vehicle-specific supplementary kits - **KL-0029-1..**

Suitability: **VW** **AUDI** **SEAT** **ŠKODA** **BMW** **FORD**

Code	No.	Load (max.)	Span* (min/max)	Clamping range*	Drive for compression nut
3434419	KL-0029-200 K	17,500 N	250 - 410 mm	160 mm	27 mm

* = without support plate

KL-0029-110 A

SUPPLEMENTARY KIT VW-AUDI

Size 1, size 2, size 3



7 parts

Fits VW-Audi, Seat, Škoda vehicles on MQB, PQ25, PQ35, and NSF platform.

- For easier removal of the suspension strut
- Only in combination with the spring preloading basic tool KL-0029-100 / -100 A

Suitability: **VW** **AUDI** **SEAT** **ŠKODA**

Code	No.	Content	Weight
3127850	KL-0029-110 A	1x KL-0029-111 - Support plate, size 1; 1x KL-0029-120 A - Supplementary kit, size 2; 1x KL-0029-130 A - Supplementary kit, size 3	3.5 kg

KL-0029-122

SUPPLEMENT KYB FOR KL-0029-120 A, VW AUDI



Fits VW-Audi, Seat, and Škoda vehicles on PQ35 platform, with aftermarket struts by KYB (KAYABA) (e.g. KYB 334834)

- With the supplement, the spring compressor base unit KL-0029-100 A in combination with the supplementary kit KL-0029-110 A / 120 A is also suitable for vehicles with aftermarket suspension struts from KYB (KAYABA)

Necessary accessories:
KL-0029-120 A - Supplementary kit size 2 (included in KL-0029-110 A)

Suitability: **VW** **AUDI** **SEAT** **ŠKODA**

Code	No.	Weight
3256162	KL-0029-122	0.35 kg

KL-0029-170

SUPPLEMENTARY KIT



Made in Germany



Suitable for VW front axle suspension struts. Installed in, for example, VW T5 (7J, 7H, 7E, 7F).

- For the easier removal and installation of the suspension strut
- Only in combination with the spring preloading basic tool KL-0029-100 / -100 A

2 parts

Code	No.	Content	Size	Weight
2952815	KL-0029-170	Support plate size 7 with bolt, Support ring size 7	7	2.3 kg

KL-0029-160 A

SUPPLEMENTARY KIT

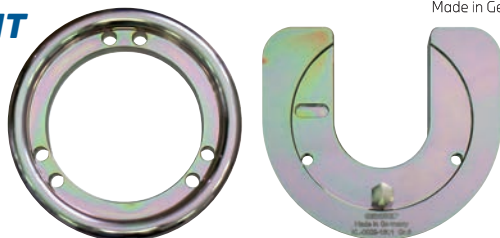

Made in Germany



Fits BMW front axle suspension struts, for example, BMW 3 Series (E46 / E90 / E91 / E92); 5 Series (E39 / E60 / E61); 1 Series (E81 / E87); X1 (E84).

- For easier removal of the suspension strut
- Only in combination with the spring preloading basic tool KL-0029-100 / -100 A

2 parts

Code	No.	Content	Size	Weight
3275221	KL-0029-160 A	Support plate size 6 with bolt, Support ring size 6	6	2.3 kg

KL-0029-150

SUPPLEMENTARY KIT FORD, SIZE 5



Made in Germany



Suitable for Ford front axle suspension struts. Installed in, for example, Ford Mondeo IV (BA7), S-Max (WA6), and Galaxy (WA6).

- For easier removal of the suspension strut
- Only in combination with the spring preloading basic tool KL-0029-100 / -100 A

4 parts

Code	No.	Content	Size	Weight
3077233	KL-0029-150	Support plate size 5 with bolt, support ring size 5, 2 extension sleeves	5	3.6 kg

KL-0029-152

SUPPLEMENTARY KIT FORD, SIZE 8

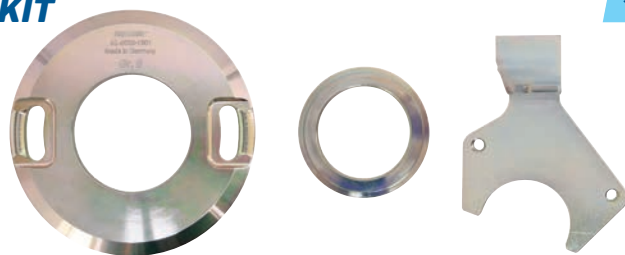

Made in Germany



Fits Ford front axle suspension struts, for example, Ford Kuga I and Kuga II (DM2).

- For the quick removal and installation of the McPherson strut
- Only in combination with the basic tool KL-0029-100 / -100 A

3 parts

Code	No.	Content	Size	Weight
3419290	KL-0029-152	1x Support ring size 5, 1x Complementary kit Ford, size 8, small	8	2.5 kg

KL-0029-1520

SUPPLEMENTARY KIT, FORD, SIZE 8



Made in Germany



Fits Ford front axle suspension struts, for example, Ford Kuga I and Kuga II (DM2).

- For the quick removal and installation of the McPherson strut
- Only in combination with the basic tool KL-0029-100 / -100 A and support ring KL-0029-1501

2 parts

Code	No.	Content	Size	Weight
3419282	KL-0029-1520	1x Adapter ring with O-ring, 1x support plate size 8 with support	8	1.2 kg

KL-0104-21 KB

ADJUSTABLE SPREADING TOOL

with wedges (Nos. 1 + 2 + 4 + 5)

Suitable for strut clamping holes and support joint mounts.

- Enables the professional widening of the strut clamping hole or the lower suspension joint mounting
- To pull out stuck shock absorber units or suspension joints without damaging them

Advantages:

- No canting of the spreading tool!
- No over-expansion of the strut clamping hole thanks to expansion wedges with stop!
- No damaging of the cast metal or aluminium steering knuckle housing!
- Off-centre clamping slots are no problem!



6 parts

Made in Germany



Suitability: universally, especially for:

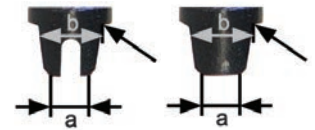

Code	No.	Spreading dimension	Weight
3269396	KL-0104-21 KB	Wedge 1: a=5.5 mm, b=12.0 mm / wedge 2: a=2.0 mm, b=8.0 mm / wedge 4: a=5.5 mm, b=9.5 mm / wedge 5: a=12.5 mm, b=17.0 mm	1.75 kg

KL-0015

SPRING COMPRESSOR

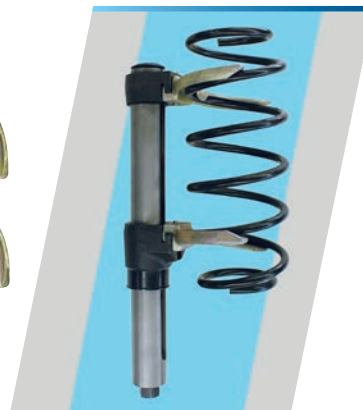
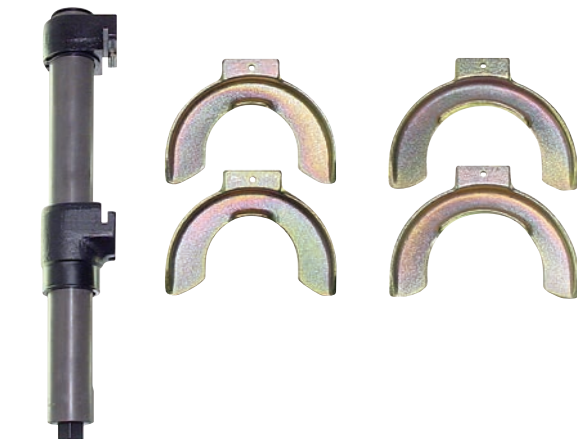

Made in Germany



Suitable for suspension strut axles, including spring retaining pair size 1N and 2N for spring diameter of 80 mm (inside) - 195 mm (outside).

- Self-locking mechanism of the movable holder / lifting carriage
- Can be also used for conical springs
- Plastic protective inserts (option)
- Maximum safe work

Note: Further spring retainers for spring diameters of 70 - 240 mm available

Suitability: universally

Code	No.	Span width (min.)	Span width (max.)	Spring Ø inside (min.)	Spring Ø outside (max.)	Operating stroke	Overall length	Drive	Load (max.)	Breaking point
1751379	KL-0015	50 mm	345 mm	80 mm	195 mm	295 mm	475 mm	SW 27	17,500 N	70,000 N

KL-1590-2

ADAPTER SET

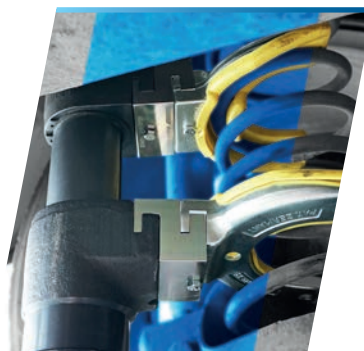

Made in Germany



Universal fit.

- For extending the spring retainer of KL-0015 and KL-2000, for example when tensioning the VW Lupo rear axle spring or on barrel springs

Suitability: universally, especially for:



Code	No.	Extension (per adapter)	Weight
2159376	KL-1590-2	27 mm	1.2 kg

UNIVERSALLY
FAST
EFFECTIVE
SAFE
E-MOBILITY-READY



KL-5501 B

SPRING COMPRESSOR stationary

Quick, easy, and effective compressing of almost any McPherson spring strut / shock absorber suspension leg available on the market, combined with maximum safety. As the spring is compressed via the upper spring collar against the lower one, spring shape or spring pitch do not play any role.

EASY ASSEMBLY

Assembly at the MODULO tool / assembly trolley - KL-4999-120 A / -121 A with the help of the fastening kit - KL-5501-211

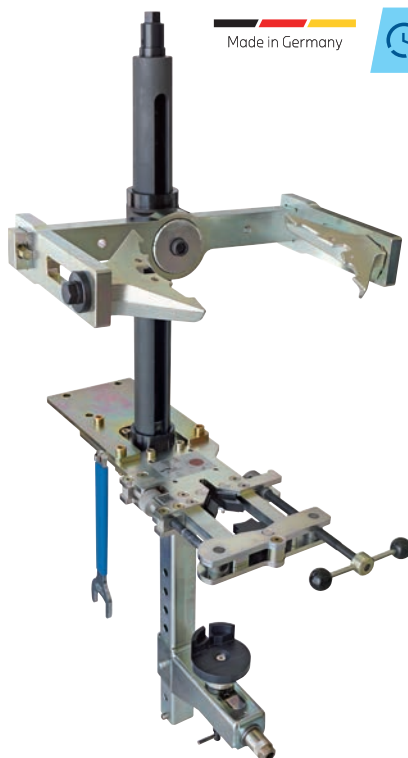

Made in Germany



Universal fit for nearly all McPherson spring struts on the market.

Fits particularly for right or left rising springs, conical springs, eccentric springs, springs with a low number of coils, springs with a high or varying spring pitch, spring struts with tension stop springs as well as for spring struts with electronic control and sensors.

- **UNIQUE, QUICK and SAFE**, simply **BETTER!**
- Tensions even the strongest springs - **E-MOBILITY-READY**
- Damage-free holding over the damper tube
- Safe tensoning directly via the dome bearing
- Spring form and pitch completely irrelevant
- No intervention into the spring necessary
- Maximum user safety
- Simplest handling
- One-man operation
- High load capacity
- 4-way safety



Application video

Code	No.	Drive	Breaking point	Max. load:	Weight	Max. span	Spring collar diameter
3230503	KL-5501 B	SW 24	60 000 N	15 000 N	46 kg	570 mm	125 - 220 mm

KL-5501-1435 A
ADAPTER RING



Made in Germany



Fits spring struts with fork mount.

- Enables the safe reception of suspension struts with fork mounting on the lower support on the stationary spring compressor **KL-5501 / KL-5501 B**

Suitability: universally, especially for:



Code	No.	Adapter Ø	Thickness
3406199	KL-5501-1435 A	57 mm	20 mm

KL-5501-40
HAND CRANK

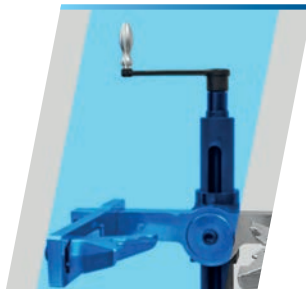

Made in Germany



- The hand crank enables a simple and fast drive of the stationary spring compressor **KL-5501 or KL-5501 B** when compressing and releasing a McPherson strut

Code	No.	Drive (hexagon)	Length
3402444	KL-5501-40	24 mm	195 mm

KL-5501-31
COLLAR MOUNTING KIT



Made in Germany



Suitable for Renault Clio IV (Type X98); Nissan Qashqai II (J11), VW (MEB platform)

- Enables the safe grabbing of the spring collar at the spring compressor **KL-5501 / KL-5501 B**
- Easy placing of the adapter on the spring collar
- Inner diameter of the adapter 60 / 90 mm

2 parts

Code	No.	Thickness	Inner Ø 1	Inner Ø 2
3406059	KL-5501-31	10 mm	60 mm	90 mm

KL-5501-1431
PLASTIC SUPPORT
for shock absorbers

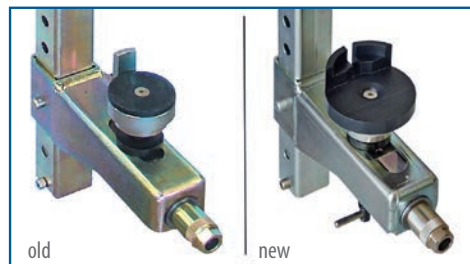
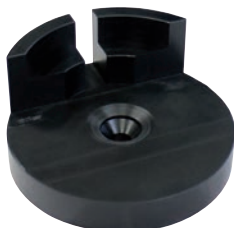

Made in Germany



- For modification of the **KL-5501** spring compressor to the newer version of the support plate

Code	No.	Overall height	Outside diameter	Weight
2793520	KL-5501-1431	47 mm	100 mm	180 g

KL-5501-191

CONVERSION KIT
compress unit, long



Made in Germany



Fits KL-5501.

- Enables the fixation of complex shock absorbers which have a very small mounting surface on the shock absorber tube
- By using KL-5501-191 and KL-5501-192, KL-5501 can be converted to KL-5501 B

Code	No.	Weight
3244032	KL-5501-191	2.8 kg

KL-5501-192

CONVERSION KIT
for the support



Made in Germany



Fits KL-5501.

- Enables the extended adjustment of the lower support
- By using KL-5501-191 and KL-5501-192, KL-5501 can be converted to KL-5501 B.

Code	No.	Weight
3244059	KL-5501-192	3 kg

KL-0056-11 E

SHOCK ABSORBER PISTON ROD TOOL KIT
In foam insert

Fits universally for McPherson struts on passenger cars.

- For quick loosening and tightening of the the piston rod nut on McPherson struts.

Advantages:

- Holder with 5/16" bit drive
- Holder with 1/4" socket drive
- Open 12 point sockets

Suitability: universally

17parts



Made in Germany



Code	No.	Content	Weight
3401472	KL-0056-11 E	Socket, open SW 16-21 mm, holder for 5/16" bits and 1/4" sockets, Screwdriver bit SW 5-7 mm, T50, XZN12, 2-point socket, 6-8 mm, open-ended spanner with ring ratchet 19 mm, Combination spanner 10 mm, foam insert	1.5 kg

KL-0050-51 A

MORTISE SOCKET
Mercedes W203



Made in Germany



NEW

Fits Mercedes C-Class (W203) and CLK (W209) front axle.

- For unscrewing and tightening the shock absorber piston rod nut (locknut).

Code	No.	Number of pins	Pin width	Drive (hexagon)	Inner diameter	Length	Width	Weight
3448568	KL-0050-51 A	2	2.6 mm	19 mm	14 mm	28 mm	22 mm	50 g

KL-0033-10 E Z

INTERNAL-TYPE SPRING COMPRESSOR, COMPACT with size 2A and 0A



Universal fit for chassis springs on transverse and trailing arm axles, for example on Audi A4 B8 (8K), A5 (8T), A6 (C7 / 4G), A7 (C7 / 4G), Q5 (8R); Mercedes-Benz E-Class (W211, W212), C-Class (W204), GLA (X156), GLK (X204); Ford Focus II (MK2); BMW 1 Series (E81); VW Passat (B8/3G).

- Enables the quick and safe removal and installation of chassis springs
- For very small through holes (approx. 34 mm dia.) in the wishbone

Advantages:

- Very compact design (approx. 34 mm diameter)
- No wheel alignment necessary
- Very high time saving
- Very safe compressing due to 3-point safety locking
- No unscrewing of the spring

Recommended accessories:

KL-0033-300 E - Hold-down device kit with foam insert

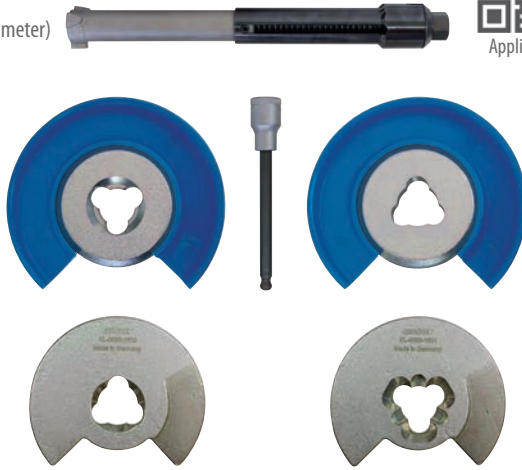

Application video



Suitability: universally, especially for:



6 parts

Code	No.	Max. load	For spring diameter	Operating stroke	Span	Compressor cylinder diameter
3421198	KL-0033-10 E Z	30,000 N	80 mm (inside) to 130 mm (outside)	100 mm	116 - 216 mm	approx. 34 mm

KL-0033-300 E

HOLD-DOWN DEVICE TRANSVERSE AND TRAILING ARMS

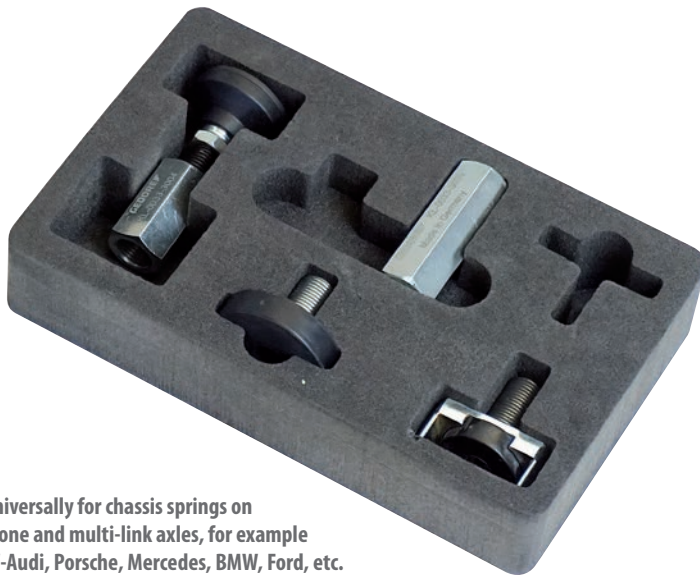

Fits universally for chassis springs on wishbone and multi-link axles, for example on VW-Audi, Porsche, Mercedes, BMW, Ford, etc.

- Facilitates the disassembly and installation of chassis springs on wishbone and multi-link axles.
- The chassis remains spring-relieved
- Increases space for spring replacement

Suitability: universally, especially for:



5 parts

Code	No.	Drive	Diameter of support	Compression distance (adjusting nut, short)	Compression distance (adjusting nut, long)
3275205	KL-0033-300 E	SW 22	40/50 mm	80 - 113 mm	105 - 138 mm



KL-4007-411

ARTICULATED HANDLE 3/4", 980 MM



- For extremely stuck screw connections
- Especially long version
- With 180° joint

3/4"

Code	No.	Drive	Total length	Max. load:
2941554	KL-4007-411	3/4"	980 mm	1,050 Nm

3550-UK-LS4

TORQUE WRENCH TORCOFLEX UK kit 1/2"

Made in Germany



Better readability
by magnifying effect

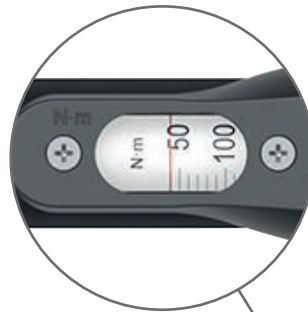

- Reliable torque wrench with a tightening range of 40-200 Nm with test certificate
- Controlled right-hand tightening; reversible ratchet with clockwise and anti-clockwise rotation; drive: 1/2"
- Classified to DIN EN ISO 6789-2:2017; Adjusted to a max. admissible deviation of +/-3 % and therefore more precise than +/-4 % required by the standard
- Through a 1/2" extension and power sockets with protective sleeve in sizes 17, 19, and 21 mm very suitable for changing wheels on passenger cars



5 parts 1/2"



Code	No.	Type	Square drive inch	Square drive metric	Content	Height	Distance housing - square centre	Length	Head width	Head height	Weight
3107027	3550-UK-LS4	Ratchet with lever switch	1/2"	12.5 mm	Torque wrench TORCOFLEX 40 - 200 Nm no. 3550-20 UK Extension no. 1990-5 Power screwdriver kit 1/2", 3-part	44 mm	21.3 mm	499 mm	42.5 mm	22 mm	2.4 kg

TF-K300

TORQUE WRENCH TORCOFLEX TF-K

Made in Germany



Socket:

- Controlled bolt tightening in the range of 60 - 300 N·m / 45 - 220 lbf·ft
- Adjustable, releasing, and robust pipe torque wrench with integrated ratchet with square drive for industry and trade

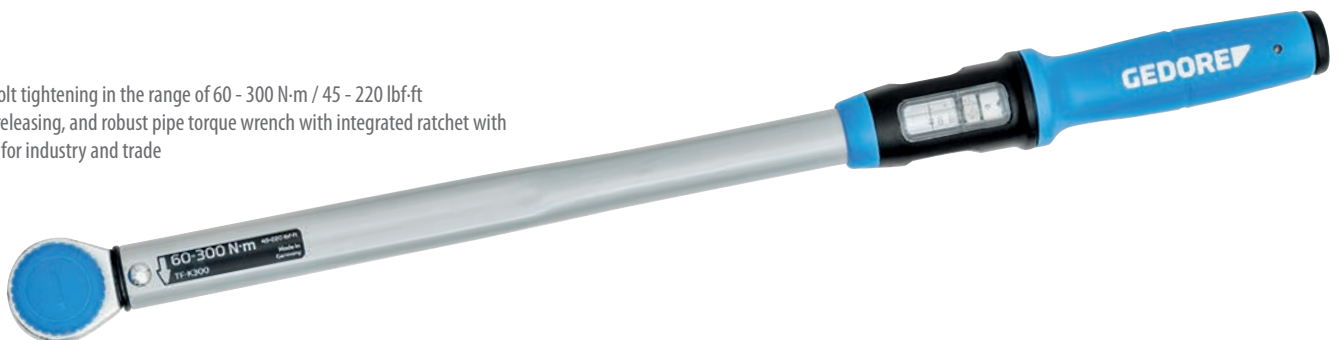

1/2"

Code	No.	Torque range	Scale division	Square drive	Return angle	Overall length
3278395	TF-K300	60 - 300 Nm	10 Nm	1/2"	7.5°	586 mm

KL-0100-80 K

SPECIAL POWER SOCKET KIT 1/2"



NEW

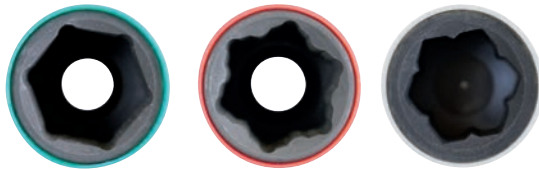

3 parts



Suitable for wheel bolts from Mercedes, Tesla, Hyundai and Kia with special profile.

- For unbolting and tightening wheel bolts
- Slim version with plastic sleeve

Suitability: **MERCEDES** **TESLA** **HYUNDAI** **KIA**



Code	No.	Profiles	Drive (square)	Storage	Weight
3427692	KL-0100-80 K	Single profiles / hexagon	1/2"	in case	900 g

KL-0100-81 K

POWER SOCKET KIT, HALF SIZE, 1/2"



NEW



Suitable for wheel bolt connections with half sizes SW 16.5 - 21.5.

- For unbolting and tightening wheel bolts / release nuts
- Required for damaged chrome bolts/nuts
- Half a spanner size smaller when chrome cap is missing
- Half a spanner size larger in case of extended chrome cap (corrosion)

Suitability: universally, especially for: **FORD**



6 parts

Code	No.	Profile	Drive (square)	Storage	Weight
3427773	KL-0100-81 K	6-edge	1/2"	in case	1.5 kg

THREAD RESET



Application video



SAFE, CHIPLESS REPAIR
NO WEAKENING OF THE THREAD
REPAIR IN ONLY 30 SECONDS
COMPLETE RESTORATION

- KIA CHEVROLET
- JEEP HYUNDAI
- LADA DAIHATSU
- SUZUKI ISUZU
- SUBARU HONDA
- TOYOTA MAZDA
- JAGUAR LEXUS
- VOLVO RENAULT
- ALFA PEUGEOT
- FIAT CITROËN
- LANCIA OPEL
- SMART CHRYSLER
- NISSAN DODGE
- INFINITI FORD
- LAND ROVER
- MITSUBISHI
- VW-AUDI
- AND MANY MORE

KL-0173-612

RETHREADING TOOL FOR WHEEL STUD THREAD (M12X1.5)

Universally applicable on wheel studs and wheel bolts with M12x1.5 thread, for passenger cars and vans.

- Quick and cost-saving rethreading of damaged threads on wheel studs and wheel bolts
- The thread is formed back to its original geometry by rolling (forming, pressing, shaping), without cutting
- No material is removed in the process
- The strength of the wheel studs or the wheel bolts is completely maintained
- The thread is additionally compacted again
- Compact design
- Drive with a conventional hexagonal socket with reversible ratchet
- Thread size covers approx. 80% of approved vehicles with wheel studs!



Made in Germany



Code	No.	Drive (hexagon)	Thread	Weight
3435628	KL-0173-612	36 mm	M12x1.5	240 g

KL-0173-601

RETHREADING TOOL KIT FOR WHEEL STUD THREAD (M12X1.25 + M14X1.5)

Universally applicable on wheel studs and wheel bolts with M12x1.5 as well as 14x1.5 thread, for passenger cars and vans.

- For description see KL-0173-612



KL-0173-622



KL-0173-611



Code	No.	Drive (hexagon)	Thread	Weight
3435644	KL-0173-601	36 mm	M12x1.25 + M14x1.5	430 g

KL-0112-9

SET OF SOCKETS, BRAKES



Suitability: **AUDI** **PORSCHE** **MERCEDES**



Fits brake calliper retaining bolts on standard Audi, Porsche, and Mercedes models.

KL-0112-901 = Audi, Porsche, Mercedes

KL-0112-902 = Audi S5

KL-0112-911 = Audi Q7

KL-0112-912 = Audi S8, Q7; Porsche Macan, Cayenne, Cayman

KL-0112-913 = Audi S6, A8; Porsche Cayenne

Recommended accessories: 1993 U-20 - Reversible ratchet

Code	No.	Spanner size:	Drive	Height	Number of teeth professional
3417492	KL-0112-9	11, 22, 14, 15, 20 mm	1/2"	50 mm	7 / 10

KL-0114-55

UNIVERSAL BRAKE CALLIPER HOOK

PAIR (shapeable/flexible)



2 parts

Code	No.	Length	Weight (total)
3417352	KL-0114-55	240 mm	100 g



Universally applicable.

- Two flexibly shapeable hooks with a robust blue surface coating
- For example, they can be used for maintenance and repairs, to safely suspend brake callipers, air conditioning compressors, power steering pumps, and much more
- Damage to hoses and cables from hanging down can thus be avoided

KL-0111-1

PRESSING DEVICE

Brake pistons

Made in Germany

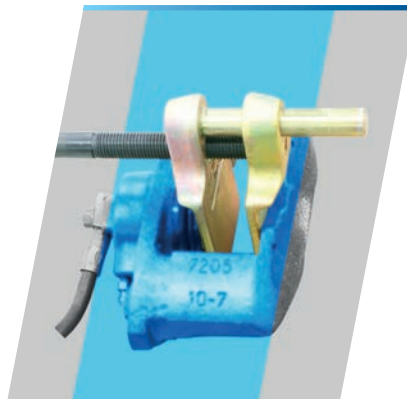
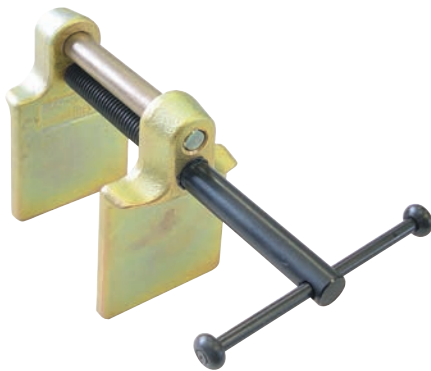

Fits universally for nearly all vehicles.

- For floating callipers with single piston and fixed callipers with two pistons
- For a quick and safe resetting of the brake piston without damaging the collar or the piston
- No canting of the piston during resetting
- Due to precise guidance, only small amount of force required
- High stability and wear resistance due to hardened plates and guide bolts

Suitability: universally

Code	No.	Max. tool length	Tool height	Usable height of the brackets	Width of the brackets	Min. span	Max. span
1752294	KL-0111-1	260 mm	125 mm	75 mm	70 mm	13 mm	70 mm

643

BRAKE CALLIPER BRUSH

Made in Germany



- For cleaning the brake calliper / brake calliper support before installing new brake pads

Code	No.	Overall length	Bristle length	Weight
6531440	643	225 mm	21 mm	85 g

KL-0414-2

DRIVE SHAFTS DISASSEMBLY LEVER

Made in Germany



Universally suitable for passenger cars and vans with plugged-in drive shafts on the gearbox.

- For a simple pressing out of drive shafts
- Optimum support due to adjustable articulated foot

Suitability: universally, especially for:



Code	No.	Length	Blade width	Weight
3421171	KL-0414-2	610 mm	40 mm	1.4 kg

KL-0121-96 B

CLAMPING PLIERS

for steering and axle boots

Made in Germany



Fits axle boots, steering boots, cooling water hoses, fuel lines, etc.

- For professional closing of stainless-steel pinch clamps and tension clamps

Advantages:

- Torque tightening possible
- Including exchangeable pliers fingers
- Pliers fingers can be mounted at the FRONT or at the SIDE

Suitability: universally, especially for:



5 parts 3/8"



Code	No.	Length in mm	Drive
3410129	KL-0121-96 B	260	3/8"

KL-0121-9611

CHANGEABLE JAW KIT WITH HOOKS



Fits universally, for example BMW.

- For closing of special hose clips
- In combination with KL-0121-96 A

Code	No.	Length	Width	Weight
3428486	KL-0121-9611	25 mm	18 mm	80 g

KL-0121-512

HOSE CLAMP PLIERS



NEW



Universal fit.

- For removal and installation of hoses secured by spring band clamps
- For straight or 90° offset applications



Code	No.	Head width	Length	Weight
3435504	KL-0121-512	16 mm	205 mm	300 g

KL-0167-30 A

EXCENTRIC WRENCH FOR REMOVAL AND INSTALLATION OF AXIAL JOINTS



Fits universally for cars and vans.

- For the quick removal and installation of internal track rods or axial joints with a \varnothing of 30 - 43 mm

Advantages:

- High time saving
- Without removing the steering gear
- Unique open construction
- Resistant profiling reliably prevents slipping of the tool
- Direct mounting on the tie rod
- Drive via 1/2" square socket



Application video



Suitability: universally, especially for:

VW-AUDI	BMW	CITROËN	DACIA	FORD	HYUNDAI
KIA	MAZDA	MERCEDES	MINI	NISSAN	PEUGEOT
OPEL	VOLVO	PORSCHE	RENAULT	SEAT	ŠKODA

Code	No.	Drive	For \varnothing (min.)	For \varnothing (max.)
3427900	KL-0167-30 A	1/2"	30 mm	43 mm

KL-4007-3270

EXTENSION 700 MM, 1/2"



Universal fit.

- Especially suitable for KL-0167-30 / -30 A
- For hand-operated socket spanners
- With ball lock.

NEW

1/2"

Code	No.	Head width	Length	Weight
3447707	KL-4007-3270	16 mm	205 mm	300 g

KL-0165-1

BALL JOINT BREAKER KIT SIZE 1 + SIZE 2

Made in Germany



For removing ball joint connections on axle and steering systems.

Advantage:

- Variable due to exchangeable forks
- High stability
- Ideal release pressure point and breaking angle adjustable

Recommended accessories:

1993 U-20 - Reversible ratchet 1/2"

Code	No.	Size	SW	Dimensions	Weight
1753592	KL-0165-1	Size 1 + 2	19 mm	W 450 mm / H 123 mm / D 360 mm	10.5 kg

KL-0164-3

BALL JOINT BEAD BREAKER

Made in Germany

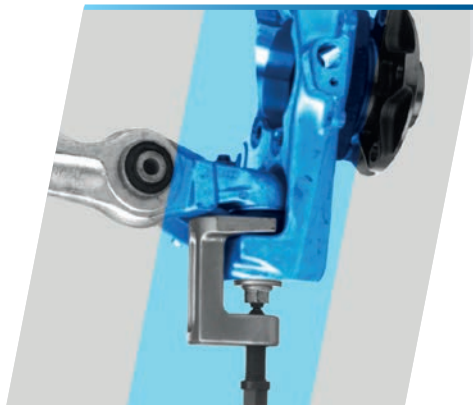
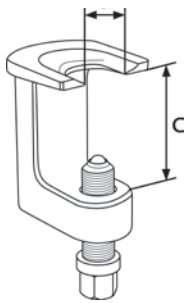

In particular for narrow space conditions for example VA at VW-Audi, VW, Mercedes, Renault etc.

- For pressing out the ball joint pin

Suitability: **VW** **AUDI** **MERCEDES**
ŠKODA **RENAULT** **ETC.**

Note:

Only for closed pivot pins or centre bore

Code	No.	Fork opening (a)	Hight inside (c)	SW	Spindle	Weight
1753576	KL-0164-3	28 mm	55 mm	17 mm	M16x1.5 x 50	900 g

KL-0326-170

SUSPENSION JOINT RELEASE TOOL KIT

Made in Germany



Suitable for suspension joint bolts on-link axles, for example, Mercedes C-Class (W205), E-Class (W213), EQC (N293), GLC (X253), and many others.

- For professional unscrewing and tightening of suspension joint bolts
- With inlay ring SW32 and SW24 and changeable screwdriver in-hex sockets (T45 + T50), individually adjustable to the suspension joint

Suitability: **MERCEDES**

5 parts

Code	No.	Suspension joint nut	Profile for suspension joint nut	Support joint	Profile for suspension joint	Drive
3427633	KL-0326-170	SW24 + SW32	Double hexagon	T45 + T50	Female Torx	SW19 + SW13

KL-0115

HOLDING TOOL FOR WHEEL HUBS

Made in Germany

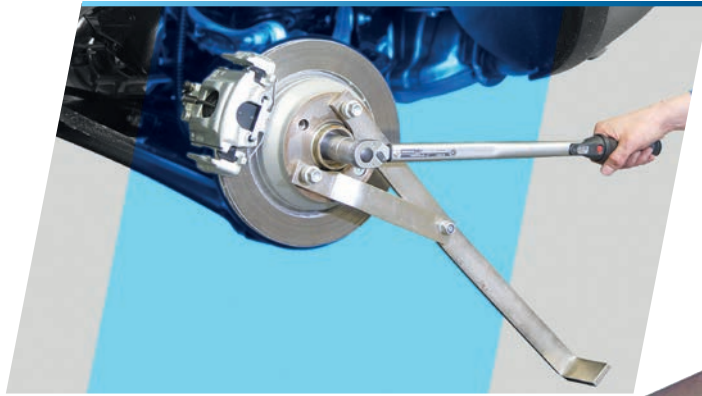

Suitable for nearly all passenger cars and vans.

- For counter-holding the wheel hub when unscrewing or tightening the fastening screw or nut on the front / rear axle drive shaft or on the wheel bearing

Suitability: universally

Code	No.	Length	Length of swivel arm	Bore diameter	Weight
2385678	KL-0115	620 mm	293 mm	14.5 mm	3.3 kg

KL-0174-110

PULLER SET

Made in Germany



Fits universally for wheel bolt systems with M12x1.5 and 14x1.5

- For mechanically pressing out cardan shafts
- For pulling out the wheel hub, stub axle etc. with an impact extractor (accessories)
- The cardan shaft can be pressed out hydraulically (accessories required)

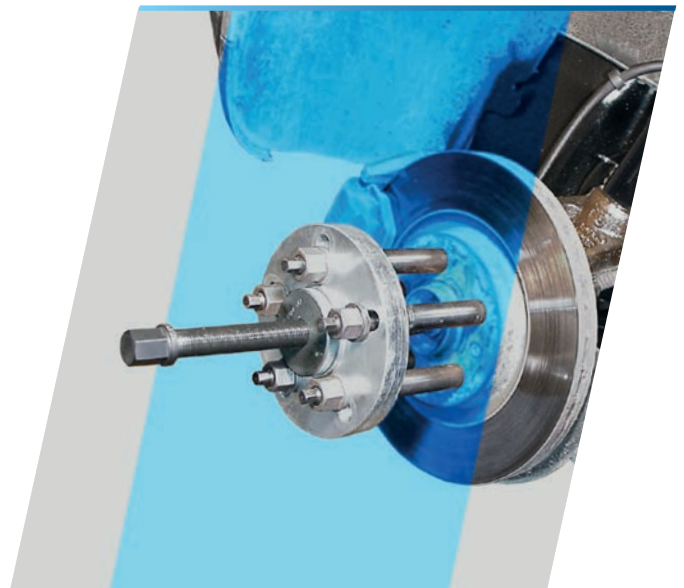

15 parts

Code	No.	Design	Receiving thread	Hole circle Ø	Drive type	Weight
1957740	KL-0174-110	Type B	M12x1.5 M14x1.5	45 - 65 mm	Hydraulic / mechanical	6.4 kg

KL-0174-545

ADAPTER

2 1/4"-14 UNS to M18

Made in Germany



Suitable for KL-0174 series.

- For the use of a M18 spindle on a 2 1/4"-14 UNS mounting thread

Code	No.	External thread	Internal thread	Outside diameter	Length	Weight
1920685	KL-0174-545	2 1/4"-14 UNS	M18	65 mm	40 mm	740 g

KL-4999-2504 E

SUPPLEMENT WHEEL BEARING MB

Made in Germany



39 parts

Suitability: **MERCEDES** **VW**

NEW

Suitable for the front axle of Mercedes Vito / Viano / V-Class (W639, W447), Sprinter (W906) and VW Crafter (2E/2F) with front-wheel drive, rear drive or all-wheel drive.

- For removal and installation of the wheel bearing unit or of the wheel bearing with wheel hub directly on the vehicle
- For wheel hubs with and without centre bore
- No need to replace the entire steering knuckle
- No wheel alignment required
- As supplement for Modulo KL-4999-250 / -260

Code	No.	Load (max.)	Drive type	Storage	Width	Height	Depth
3441504	KL-4999-2504 E	17 t	hydraulic	with foam insert	995 mm	140 mm	465 mm

KL-0041-521 K

WHEEL BEARING TOOL KIT

Vito/Viano VA

Made in Germany



NEW

Suitable for the front axle of Mercedes Vito / Viano, V-Class (W639, W447) with rear drive.

- For removal and installation of the wheel bearing unit directly on the vehicle
- Required for wheel hubs without centre bore
- No damage to the bearing, as pressure during installation is only applied via the outer bearing ring
- No need to replace the entire steering knuckle
- No wheel alignment required
- Additional mechanical drive parts necessary!

Suitability: **MERCEDES**



28 parts

Code	No.	Load (max.)	Drive type	Storage	Width	Height	Depth
3441350	KL-0041-521 K	17 t	hydraulic	in case	442 mm	151 mm	357 mm

KL-0041-522 K

WHEEL BEARING TOOL KIT

Vito/Viano VA

Made in Germany



NEW

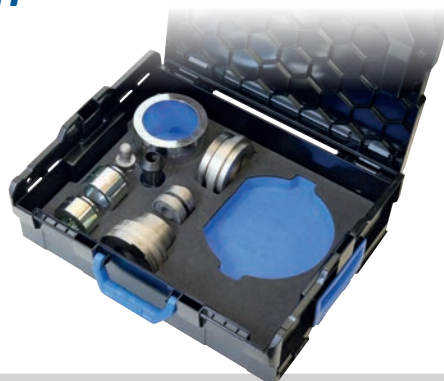

Suitable for the front axle of Mercedes Vito / Viano, V-Class (W639, W447) with front-wheel as well as with all-wheel drive.

- For removal and installation of the wheel bearing and wheel hub directly on the vehicle
- Only for wheel hubs with centre bore
- Additional mechanical drive parts necessary!

Suitability: **MERCEDES**

15 parts

Code	No.	Load (max.)	Drive type	Storage	Width	Height	Depth
3441377	KL-0041-522 K	17 t	hydraulic	in case	442 mm	151 mm	357 mm

KL-8041-100 A

WHEEL BEARING KIT

Made in Germany



49 parts

Universal fit.

- The premium wheel bearing package enables the quick, precise and safe removal and installation of wheel bearings, wheel hubs, pluggable axles as well as of cardan shafts
- Even extremely stuck or rusty wheel bearings, can be easily pulled off with the hydraulic cylinder

Necessary accessories: Hydraulic pump

Suitability: **VW** **AUDI** **BMW**
FORD **VAUXHALL/OPEL**

Code	No.	For Ø (min.)	For Ø (max.)	Drive	Content
3005798	KL-8041-100 A	60 mm	85 mm	mechanical hydraulic	Wheel bearing tool kit, puller set for cardan shafts, impact extractor 4.8 kg, supplementary kit for drive shafts, hydraulic drive, hydraulic cylinder 17 t

KL-8041-300

PREMIUM WHEEL BEARING PACKAGE

Made in Germany



68 parts

Universal fit.

- For a professional removal and installation of wheel bearings, wheel hubs and cardan shafts
- Even extremely stuck or rusty wheel bearings, can be easily pulled off with the hydraulic cylinder

Necessary accessories: Hydraulic pump

NEW

Code	No.	For Ø (min.)	For Ø (max.)	Drive	Content
3434974	KL-8041-300	60 mm	85 mm	mechanical hydraulic	Wheel bearing tool kit, wheel hub puller kit, impact extractor 4.8 kg, supplementary kit for drive shafts, hydraulic drive, hydraulic cylinder 17 t

KL-0041-452 C

WHEEL-BEARING MOUNTING TOOL Ø 85 MM

Made in Germany



Suitable for rear axles with wheel bearing Ø 85 mm, for example on Toyota ProAce; Peugeot Expert, Traveller; Citroen Jumpy; Opel Zafira, Vivaro, Renault Traffic, Fiat Talento etc.

- For removal and installation of the wheel bearing unit directly on the vehicle
- Required for wheel hubs without centre bore
- No damage to the bearing, as pressure during installation is only applied via the outer bearing ring

Additional mechanical drive parts necessary!

- KL-0040-2500 - Hydraulic cylinder, 17 t
- KL-0039-802 - Hydraulic drive
- KL-0041-380 A - Wheel hub extractor
- KL-0215-35 M25 - Hand pump or
- KL-0215-36 M25 - Foot pump

Suitability:

TOYOTA **PEUGEOT** **CITROËN** **RENAULT** **VAUXHALL/OPEL** **FIAT**

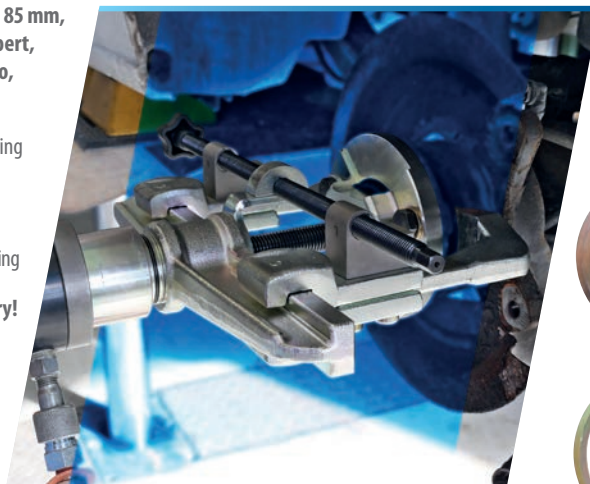

NEW



Code	No.	for outside diameter (bearing)	Hole circle Ø	Load (max.)	Drive type
3445828	KL-0041-452 C	85 mm	5x98 5x100 5x108 5x112	17 t	hydraulic

KL-0041-4521

PULLER PLATE WITH SCREWS

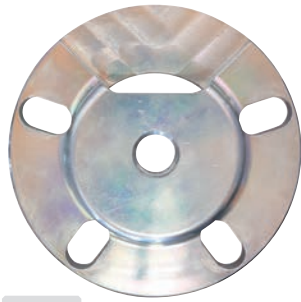

NEW

Accessory necessary!
 KL-0041-380 A - Wheel hub extractor
 KL-0041-451 B and KL-0041-461 D -
 Wheel bearing mounting tool

Suitable for rear axles with wheel bearing \varnothing 85 mm, for example on Toyota ProAce; Peugeot Expert, Traveller; Citroen Jumpy; Opel Zafira, Vivaro, Renault Traffic, Fiat Talento etc.

- For removal of the wheel bearing unit directly on the vehicle
- Required for wheel hubs without centre bore
- As supplement for Modulo KL-4999-250 / -260 / -270

9 parts

Suitability: **TOYOTA** **PEUGEOT** **CITROËN** **RENAULT** **VAUXHALL/OPEL** **FIAT**

Code	No.	Outside diameter	Drive type	Height
3445836	KL-0041-4521	135 mm	hydraulic	35 mm

KL-0041-380 EA

WHEEL HUB EXTRACTOR

with foam insert

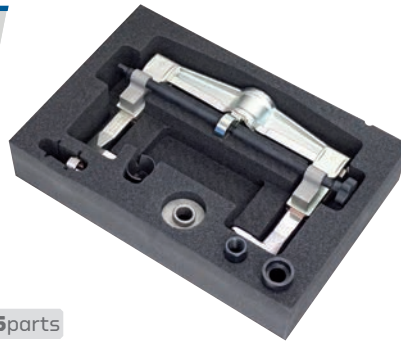
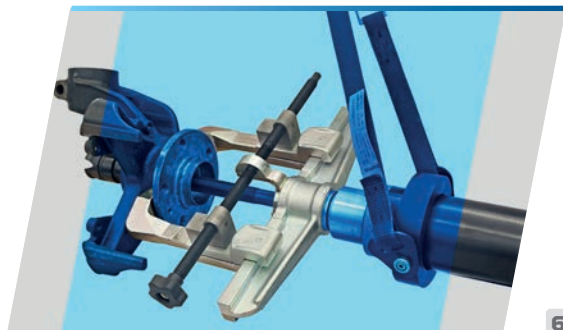

6 parts

Universally fits wheel hub / wheel bearing units, wheel hubs, and wheel bearings with a diameter of up to 250 mm.

- For pulling out wheel hub bearing units
- For pulling out wheel hubs and wheel bearings from the wheel bearing housing
- Construction chargeable up to 12 tons design
- Even glued, stuck or rusty wheel hub bearing units, wheel hubs and wheel bearings do not pose a problem
- Drive with the 17t hydraulic cylinder KL-0040-2500

Code	No.	Max. span width	Max. load capacity	* in combination with thrust spindle (1.2606280KS)
3277631	KL-0041-380 EA	up to 250 mm	12 t *	7 t

KL-0049-360 A

HOOK FOR IMPACT EXTRACTOR



Universally applicable.

- For pulling suspension ball joints out of the steering knuckle, for body work, etc.
- Slim design

Suitability: universally

Code	No.	Total length	Width	Connection thread
3411001	KL-0049-360 A	155 mm	25 mm	M18

KL-0049-300

IMPACT EXTRACTOR 4.8 KG

Base unit



- For pulling out stuck stub axles, cardan shafts, injection nozzles, injectors, etc.
- In connection with the individual adapters or tension bolts

Suitability: universally

Code	No.	Impact weight	Length	Receiving thread
2379228	KL-0049-300	4.8 kg	680 mm	M18

KL-0040-2500

HYDRAULIC CYLINDER 17 T

Made in Germany



- The hollow-piston cylinder is suitable for pulling and pushing
- For the removal and installation of cardan shafts, silent blocks and suspension joints

Necessary accessories: Hydraulic pump

Suitability: universally

Code	No.	Max. admissible force:	Max. stroke	Oil pressure (max.)	Thread with hollow piston	Fastening thread thrust side	Fastening thread pull side	Outer diameter of cylinder	Overall cylinder height retracted/extended:	Connection thread for hydraulic coupling	Weight
1751441	KL-0040-2500	170 kN (17 t)	45 mm	700 bars	M20	2 1/4" -14 UNS	M42x2	80 mm	202 - 247 mm	3/8" NPT	5.7 kg

KL-0215-35 M25

HAND PUMP (manual)



- The hydraulic hand pump can be used as a drive for the hydraulic cylinders **KL-0040-2500** or **KL-0040-1700**
- The ton scale allows to check the hydraulic pressure and the required power during the work

Suitability: universally

Code	No.	Pressure (max.)	Drive type	Weight
2478641	KL-0215-35 M25	700.0 bars	manual / hydraulic	7.5 kg

KL-0215-36 M25

FOOT PUMP (pneumatic)

Made in Germany



- Can be used as hydraulic cylinder drive
- Compressed air is used for driving
- Foot pedal with three positions for pumping, holding and relieving
- Both hand are free for the work

Suitability: universally

Code	No.	Pressure (max.)	Operating pressure	Drive type	Weight
2478706	KL-0215-36 M25	700.0 bars	8 - 12 bar	pneumatic / hydraulic	8 kg





MODULAR
ORGANISED
POWERFUL
UNIVERSAL

KL-4999-250 / KL-4999-260 / KL-4999-270

ASSEMBLY TROLLEY MODULO

**The mobile workplace for
wheel bearing and silent block repairs**

The hand tools and drive parts included in the trolley mean that the tools required for the application are available at any time. No additional hand tool trolley is required.

Additionally, it offers an ideal work surface with its large, solid multiplex countertop. The drawers are equipped with individual pull-out stops and full extension.

Dimensions W 1.200 x H 985 x D 635 mm



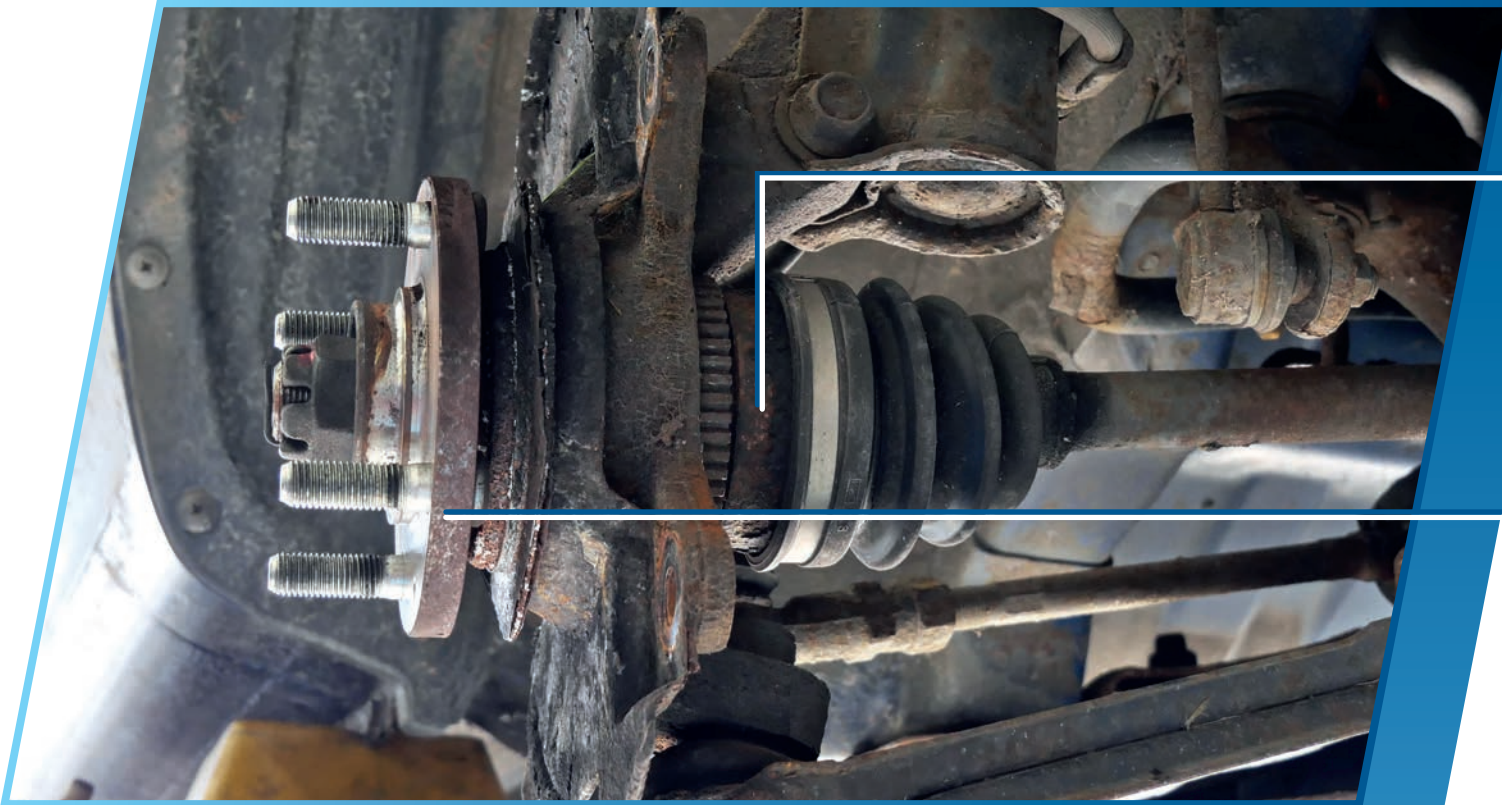

MODULO FOR AXLE REPAIRS:
*Once invested perfectly
equipped for the future!*



Drive shaft and wheel bearing/hub



Wheel bearing inner ring

- Pulling off bearing inner ring
- for example wheel bearing 1st and 3rd generation

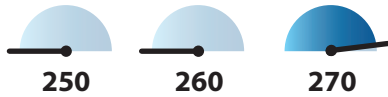

Drive shaft

- Pressing out the drive shaft from the wheel hub



1. Generation wheel bearing

- Pulling off wheel hub
- Removal and installation of wheel bearing
- Installation of wheel hub
- for example also **Mercedes Vito/Viano HA, Audi Q7 HA**



2. Generation wheel bearing

- Removal and installation of wheel hub bearing units
- with and without spring ring
- without load on the new wheel bearing during installation
- for example **VW-Audi, Ford, Mazda, Volvo, ...**



3. Generation wheel bearing

- Removal of slightly stuck wheel hub bearing units
- Removal of extremely stuck wheel hub bearing units with **Subaru, etc.**



Silent block and ball joint



Ball joint connection

- Breaking of ball joint connections
- for example suspension joint, track rod, etc.

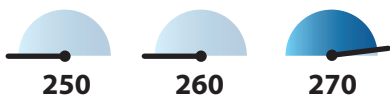

Support joint

- Removal and installation of ball joints directly on the vehicle

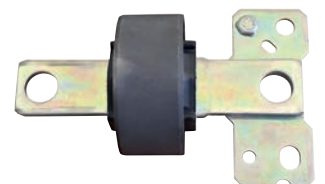

Silent block

- Removal and installation of silent blocks directly on the vehicle
- With and without press frame



MODULO ASSEMBLY TROLLEY

KL-4999-250

"MODULO 250" ASSEMBLY TROLLEY

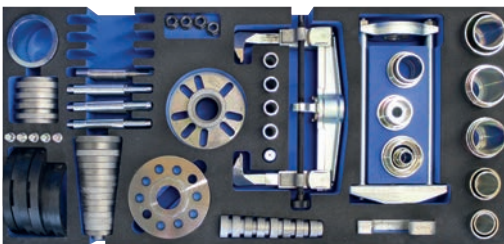
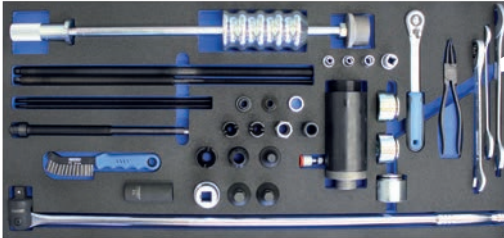

The assembly trolley is the ideal, mobile workstation for fast, organised, and efficient repairs.

Content / range of application:

- Various drive parts for operating the tool kits
- Removal and insertion of wheel bearings and hubs
- Removal and insertion of wheel hub bearing units
- Pulling of wishbones from the support joint clamping hole
- Removal of bonded and jammed joint shafts
- Various helpful hand tools

Required drive parts:

KL-0215-35 M25 - Hydraulic pump

Suitability: universally

127parts

Code	No.	Load-carrying capacity (static / dynamic)	Load-carrying capacity of drawer
3413349	KL-4999-250	1,000 kg / 750 kg	70 kg

KL-4999-260

"MODULO 260" ASSEMBLY TROLLEY

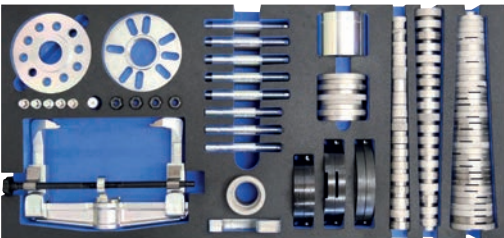

The assembly trolley is the ideal, mobile workstation for fast, organised and efficient repairs.

Content / range of application:

- Various drive parts for operating the tool kits
- Removal and insertion of wheel hub bearing units
- Pulling of wishbones from the steering knuckle clamping hole
- Removal and insertion of wheel bearings and hubs
- Removal of bonded and jammed joint shafts
- Pulling and forcing into place of support/guide joints, silent blocks and joint bearings
- Pulling of stuck screwed wheel bearing units
- Also suitable for Subaru wheel bearings as well as Ford/Mazda/Volvo silent blocks rear axle
- The universal solution for nearly all axle repairs
- Various helpful hand tools

Required drive parts: KL-0215-35 M25 - Hydraulic pump

Suitability: universally

189parts

Code	No.	Load-carrying capacity (static / dynamic)	Load-carrying capacity of drawer
3423468	KL-4999-260	1,000 kg / 750 kg	70 kg



Universally applicable for repairs on wheel bearings, steering and axle systems on passenger cars and vans.

Made in Germany



KL-4999-270

"MODULO 270" ASSEMBLY TROLLEY

The assembly trolley is the ideal, mobile workstation for fast, organised, and efficient repairs.



Content / range of application:

- Various drive parts for operating the tool kits
- Removal and insertion of wheel bearings and hubs
- Removal and insertion of wheel hub bearing units
- Pulling of wishbones from the support joint clamping hole
- Removal of bonded and jammed joint shafts
- Pulling and forcing into place of support/guide joints, silent blocks and joint bearings
- Pulling of stuck screwed wheel bearing units
- Counter-holding of wheel hubs when loosening and tightening the wheel bearing central bolt
- Pulling of stuck wheel bearing inner rings from the wheel bearing
- Compressing of ear O-clips and locking of stepless hose clips
- Separating of ball joint connections of steering and axle systems
- Loosening and tightening of inner tie bar joints or axial joints
- Also suitable for Subaru wheel bearings as well as Ford/Mazda/Volvo silent blocks rear axle
- The universal solution for nearly all axle repairs
- Also for removing inner ring bearings and breaking breaking of ball joints on passenger cars and light commercial vehicles
- Various helpful hand tools

Required drive parts:

KL-0215-35 M25 - Hydraulic pump

Suitability: **universally**

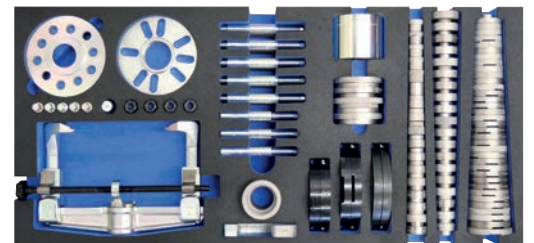

213 parts

Code	No.	Load-carrying capacity (static / dynamic)	Load-carrying capacity of drawer
3418340	KL-4999-270	1,000 kg / 750 kg	70 kg

KL-4999-1280

SURFACE-MOUNT WORKTOP

for KL-4999 series / 1507 XL



Made in Germany



Fits the MODULO workshop trolley KL-4999-12x and 1507 XL.

- To be placed on the wooden worktop
- Extremely robust, impact resistant and oil resistant
- With 2x can shelves and 8x storage compartments

Code	No.	Inner plate dimension	Material	Weight
3428001	KL-4999-1280	1202 x 639 mm	Impact and oil resistant ABS hard plastic	3.2 kg

KL-0186-14 KB

INJECTOR PULLER KIT

Universal, in plastic case

Universal fit for BOSCH and DELPHI injectors with M17x1 female thread and M14x1.5 male thread, for example, on PSA, Fiat, Mercedes, VW-Audi, Renault, Nissan, Vauxhall/Opel, Toyota, etc.

- For quick and powerful pulling of heavily stuck diesel injectors
- No removal of the cylinder head required
- Supplementary kits for engines and injectors available
- Can be operated hydraulically (accessories required)

Suitability: universally, especially for:

MERCEDES **VW** **AUDI** **CITROËN**
FORD **MAZDA** **PEUGEOT** **PSA**
SUZUKI **FIAT** **VOLVO**

45 parts



Made in Germany

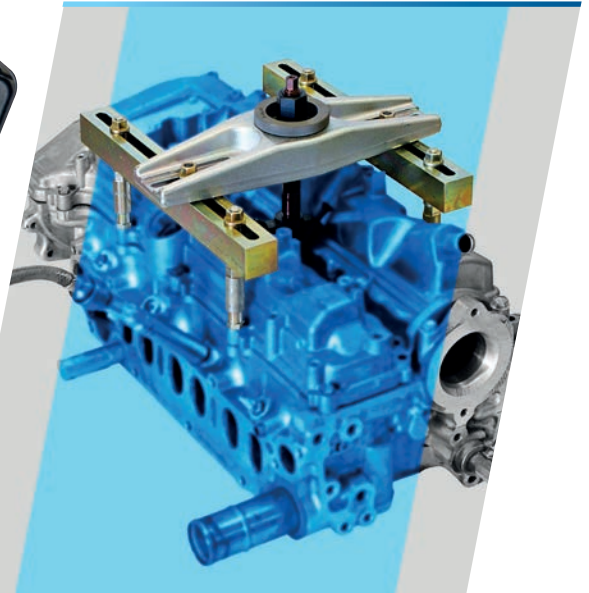

Code	No.	For female thread	For male thread	Engine type	Injectors
3420124	KL-0186-14 KB	M17x1	M14x1.5	Diesel	Bosch, Delphi

KL-0186-1281 A

SUPPLEMENTARY KIT

Siemens injector M25x1



2 parts

1/2"

Made in Germany



Suitable for Siemens - injectors with an M25x1 female thread and a spanner size of 25 mm, e.g. for VW, Audi, Seat, Škoda 1.6 TDI. (CAYA, CAYB, CAYC, CAYD, CAYE, CLNA)

- Supplement for the injector extractor KL-0186-14 KB
- Depending on the engine, the specific support bolt kit KL-0186-123../-124.. may be required

Code	No.	For injectors	Drive	Spanner size:
3420132	KL-0186-1281 A	Siemens/VDO	1/2"	25 mm

KL-0186-1282 A

SUPPLEMENTARY KIT

Siemens injector M27x1



2 parts

1/2"

Made in Germany



Suitable for Siemens injectors with a female thread M27x1 and a spanner size of 27 mm.

- Supplement for the injector extractor KL-0186-14 KB
- Depending on the engine, the specific support bolt kit KL-0186-123../-124.. may be required

Code	No.	For injectors	Drive	Spanner size:
3420140	KL-0186-1282 A	Siemens/VDO	1/2"	27 mm

KL-0186-1283 A

SUPPLEMENTARY KIT

Denso injector M16x1



2 parts

3/8"

Made in Germany



Suitable for Denso injectors with a female thread M16x1 and a spanner size of 17 mm.

- Supplement for the injector extractor KL-0186-14 KB
- Depending on the engine, the specific support bolt kit KL-0186-123../-124.. may be required

Code	No.	For injectors	Drive	Spanner size:
3420159	KL-0186-1283 A	Denso	3/8"	17 mm

KL-0186-1284 A
SUPPLEMENTARY KIT
 Denso injector M20x1

Made in Germany



Suitable for Denso injectors with an M20x1 female thread and, additionally, M25x0.5 or M25x0.75 male threads and a spanner size of 27 mm.

- Supplement for the injector extractor KL-0186-14 KB
- Depending on the engine, the specific support bolt kit KL-0186-123../-124.. may be required

5 parts $\frac{1}{2}$ "

Code	No.	For injectors	Drive	Spanner size:
3420175	KL-0186-1284 A	Denso	1/2"	27 mm

KL-0186-1285 A
SUPPLEMENTARY KIT
 Delphi / Bosch injectors (90° angle)

Made in Germany



Suitable for Delphi and Bosch injectors with lateral fuel connection (90° angle to the injector).

- Supplement for the injector extractor KL-0186-14 KB
- Depending on the engine, the specific support bolt kit KL-0186-123../-124.. may be required

2 parts

Code	No.	For injectors	Engine type	Drive type	Weight
3420183	KL-0186-1285 A	Delphi and Bosch	Diesel	Mechanical / hydraulic / manual	600 g

KL-0132-52 KB
GLOW PLUG TOOL KIT M10x1 universal

Made in Germany



12 parts

Fits universally for diesel engines with M10x1 glow plug thread, e.g. on VW-Audi, BMW, Mercedes, etc.

- For easily boring out torn glow plugs
- For recutting and cleaning the original thread on the cylinder head
- For pulling out the glow plug element
- Incl. particular guide sleeves for VW-Audi, BMW and Mercedes engines
- No need to remove or replace the cylinder head

Accessories:
 KL-0369-300 A - Turning lathe

Code	No.	For engine type	For thread	Storage
3431592	KL-0132-52 KB	Diesel	M10x1	in case

KL-0132-55 KA
GLOW PLUG TOOL KIT M8x1 universal

Made in Germany



9 parts

Fits universally for diesel engines with M8x1 glow plug thread, e.g. on Fiat, Mercedes, etc.

- For easily boring out torn glow plugs
- For recutting and cleaning the original thread on the cylinder head
- For pulling out the glow plug element
- Incl. particular guide sleeves for Mercedes and Fiat engines
- No need to remove or replace the cylinder head

Accessories:
 KL-0369-300 A - Turning lathe

Code	No.	For engine type	For thread	Storage
3431762	KL-0132-55 KA	Diesel	M8x1	in case

KL-0132-57 K

GLOW PLUG THREAD REPAIR KIT (M8x1 + M10x1)

Made in Germany



NEW



Fits universally for diesel engines with M8x1+ M10x1 glow plug thread.

- For the repair of damaged glow plug threads on the cylinder head
- No need to replace the cylinder head
- In combination with KL-0283-7021 A and KL-0283-7022 (KL-0132-52 KB)

Necessary accessories:
KL-0283-7021 A - Core drill M10x1

22 parts

Code	No.	For engine type	For thread	Storage
3431843	KL-0132-57 K	Diesel	M8x1 M10x1	in case

KL-0132-62 KB

**GLOW PLUG TOOL KIT
M10x1.25 universal**

Made in Germany



NEW

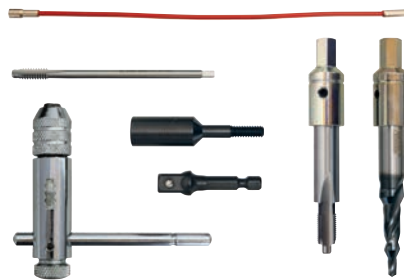

Suitable for diesel engines with M10x1.25 glow plug thread, e.g. on Opel, Mazda, Ford, Hyundai, Honda, Kia, Mini, Nissan, Toyota, etc.

- For easily boring out torn glow plugs
- For recutting and cleaning the original thread on the cylinder head
- For pulling out the glow plug element
- No need to remove or replace the cylinder head

Accessories:
KL-0369-300 A - Turning lathe

Code	No.	For engine type	For thread	Storage
3431770	KL-0132-62 KB	Diesel	M12x1.25	In plastic case

KL-0369-303 A

**ASSEMBLY/DISASSEMBLY TOOL FOR
GUIDE SLEEVE AND CENTRING SLEEVE**

Made in Germany

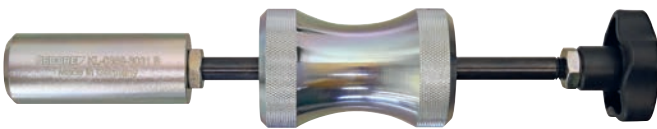

NEW

Universal fit.

- For forcing in and pressing out guide sleeves and centring sleeves
- In combination with glow plug tool kit - KL-0132-52 KB.

Code	No.	For engine type	Length	Length of sliding surface	Impact weight
3431517	KL-0369-303 A	Diesel	280 mm	150 mm	800 g



For videoscope see page 4

KL-0369-305 A

EXTRACTION TOOL FOR GLOW ELEMENT

Made in Germany



NEW

Universal fit.

- For pulling out the glow plug element
- In combination with glow plug tool kit - KL-0132-52 KB.

Code	No.	For engine type	Drive (hexagon)	Connection thread (spindle)	Length
3431495	KL-0369-305 A	Diesel	19 mm	M12x1.25	185 mm

KL-0369-201 A

GLOW PLUG EXTRACTION TOOL MERCEDES

Made in Germany



Universal fit for diesel engines with M10x1 glow plug thread and a glow plug spanner size of 10 mm.

- For pulling out glow plugs that have been unscrewed but are still stuck in the bore

Code	No.	Drive (hexagon)	For engine type	for thread	Length	Weight
2479176	KL-0369-201 A	19 mm	Diesel	M10x1	135 mm	320 g

KL-0369-202

GLOW PLUG EXTRACTION TOOL M8X1

Made in Germany



Fits universally for diesel engines with M8x1 glow plug thread and a glow plug spanner size of 8 mm.

- For pulling out glow plugs that have are still stuck in the bore

Code	No.	Drive (hexagon)	For engine type	for thread	Length	Weight
2968223	KL-0369-202	19 mm	Diesel	M8x1	135 mm	330 g

KL-0049-100 A

IMPACT EXTRACTOR BASE UNIT

Made in Germany



NEW

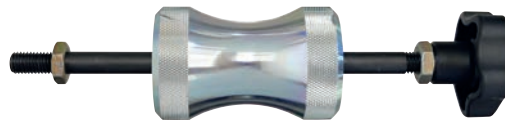

- For pulling out stuck pieces like for example injection glow plugs, spindles etc.
- In combination with the individual adapters or tool kits

Code	No.	Impact weight	Length	Length of sliding surface	Connection thread	Weight
3423611	KL-0049-100 A	800 g	215 mm	150 mm	M10	1.1 kg

KL-0049-101 A

IMPACT EXTRACTOR BASE UNIT

Made in Germany



NEW



- Required for pulling out stuck pieces like for example injection glow plugs, spindles etc.
- In combination with the individual adapters or tool kits

Code	No.	Impact weight	Length	Length of sliding surface	Connection thread	Weight
3423638	KL-0049-101 A	800 g	300 mm	235 mm	M10	1.3 kg

KL-0132-14 K

THREAD REPAIR KIT FOR EXHAUST SENSOR

Universal fit for NOx sensors, lambda sensors, and injection units for soot/particle filter regeneration with mounting threads M20x1.5 and M22x1.5.

- For quick recutting of coked or damaged mounting threads on the exhaust pipe
- Also for very confined spaces
- No removal of the entire exhaust pipe necessary
- Incl. open ring spanner for loosening and tightening the exhaust sensors and units

Made in Germany



5 parts

Code	No.	Tap	Tap length	Tap drive	Double ring spanner
3430847	KL-0132-14 K	M20x1.5 + M22x1.5	45 mm	SW13 mm	SW22 + 24 (open)

KL-0380-753 K

LOCKING TOOL KIT FOR MERCEDES 1.3

NEW



Suitable for Mercedes 1.3 petrol engines.

- For locking of the camshafts, crankshaft, flywheel and the timing belt tensioning unit

Suitability: **MERCEDES**

Code	No.	For engine type	Storage	Weight
3435717	KL-0380-753	Petrol	in case	1.8 kg

2005 XL 0221

TOOL TROLLEY with 5 drawers



Made in Germany



- Storage surface of ABS plastic with small parts compartment
- Manoeuvrable and easy to steer
- Side walls with Euro perforation
- With edge impact protection
- Central locking with cylinder clock
- Broad drawers with full-extension runners (removable)
- Safety locking per drawer, one-hand operation
- Even with maximum load capacity: smooth running, manoeuvrable, and directionally stable

Code	No.	Load capacity per drawer	Load capacity lower drawer	Total load capacity (dynamic/static)	Weight
3437515	2005 XL 0221	60 kg	70 kg	750 kg / 1,000 kg	92 kg

2005 XL 0330

TOOL TROLLEY with 6 drawers



Made in Germany



- Storage surface of ABS plastic with small parts compartment
- Manoeuvrable and easy to steer
- Side walls with Euro perforation
- With edge impact protection
- Central locking with cylinder clock
- Broad drawers with full-extension runners (removable)
- Safety locking per drawer, one-hand operation
- Even with maximum load capacity: smooth running, manoeuvrable, and directionally stable

Code	No.	Load capacity per drawer	Load capacity lower drawer	Total load capacity (dynamic/static)	Weight
3437523	2005 XL 0330	60 kg	70 kg	750 kg / 1,000 kg	97 kg

WHL-L7-TS-308
TOOL TROLLEY
 with 7 drawers

Made in Germany



309 parts

- 308 piece assortment for industry, trade and automotive
- Tools in metric dimensions
- GEDORE checking tool system: Completeness check due to 2 coloured foam inserts
- In tool trolley WHL-L7

Code	No.	Dimensions L/ W/ H	7 drawers	Weight
3082113	WHL-L7-TS-308	L 510 mm / W 785 mm / H 1045 mm	5x Type 1, H = 80 mm / 2x Type 2, H = 160 mm	112.6 kg

TS-308
TOOL ASSORTMENT
 in CT modules

Made in Germany



308 parts

- Tools in metric dimensions
- With GEDORE checking tool system: Completeness check due to 2 coloured foam inserts
- Each tool lies slip-proof in its own recess, easy to remove thanks to recessed grips
- Resistant against oils and grease

Code	No.	Content	Weight
2956535	TS-308	TS CT2-D19-D20 - 1/4" + 1/2" Socket spanner assortment in CT module TS CT2-7 - Combination spanner kit in CT module TS CT2-2154SK-119 - Tool assortment in CT module TS CT2-142 - Pliers assortment in CT module TS CT2-6-8000 - Tool assortment in 2/4 CT module TS CT2-ITX19 - 1/2" Screwdriver bit kit in 2/4 CT module TS CT2-2133-2163TX - Tool assortment in 2/ 4 CT module TS CT2-7R-2 - Screw driver kit in 2/4 CT module TS CT2-D30 - Tool assortment in 2/4 CT module TS CT2-710 - Tool assortment in 2/4 CT module 407 - Hacksaw	30 kg





THE PROFESSIONAL ALL INCLUSIVE PACKAGE

KL-4998-400

WORKSHOP TROLLEY with assortment



Universally applicable when performing maintenance and repair work on passenger cars and vans.

- Very extensive and extremely robust hand tool assortment
- Ideal, mobile workplace
- Metric design
- 8 fully equipped drawers
- One empty drawer at the very bottom
- Broad drawers with full-extension runners
- Safety locking per drawer



Drawer 1 (1/4" assortment + pliers assortment)

- **1/4" assortment:** Ratchet bit screwdriver, bit holder, bit box (32 pcs), bit adapter, reversible ratchet, T-handle, T-handle ratchet, cardan joint, extensions (55 + 97 + 148 + 305 mm), socket spanners double hex SW4-13 mm / hexagonal SW4-13 mm (long) / TXT10-40 / TX E4-10 / TX PLUS IP10-30 / TX PLUS EP6-12 / cross-head PH1-3 / slotted 5.5-6.5 / female hexagonal IN3-8)
- **Pliers assortment:** Power combination pliers, diagonal cutter, multiple pliers, flat pliers, universal pliers, circlip pliers kit (4 pcs)
- Hexagon L key kit (TX T9-40 / hexagon with ball head SW2-10 mm)
- Grip wrench brake line (11 mm)
- Steel measuring tape (5m)
- Magnetic lifter



Drawer 2 (3/8" assortment)

- **3/8" assortment:** Reversible ratchet, jointed reversible ratchet, cardan joint, extensions (125 + 250 + 305 mm), extension with holding magnet, adapter (to 1/2" + to 1/4"), socket spanners hexagonal SW6-19 / double hexagon SW10-19 (long) / TX T20-50 (short + long) / TX E6-14 / female hexagon IN4-10 (short + long) / female hexagon with ball head IN7-11 (long) / XZN M5-10 (short + long) / TX PLUS IP40-60 / TX PLUS EP10-20, glow plug socket spanner (SW14 + 16 + 18)
- Voltage tester (6-48 Volt AC/DC)
- Torque wrench (3/8", 10-50 Nm)
- Digital calliper gauge
- Feeler gauge



Drawer 3 (1/2" assortment)

- **1/2" assortment:** Reversible ratchet, telescopic reversible ratchet, T-handle, cardan joint, extension (125 + 205 mm), extension with holding magnet, adapter (to 3/8"), socket spanner hexagon SW8-32 / TX T27-60 / TX E10-24 / female hexagon IN5-17 / XZN M5-16 / TX PLUS EP22-32
- Torque wrench (1/4", 40-200 Nm)



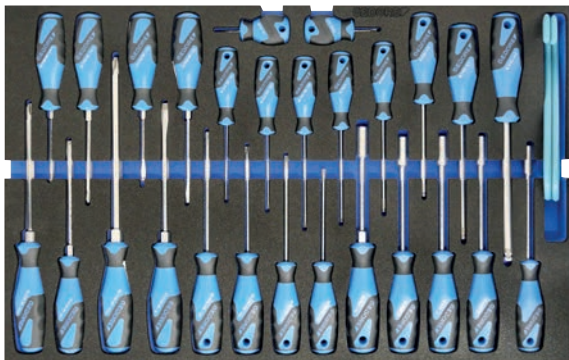

Drawer 4 (screwdriver assortment)

- Screwdriver assortment hexagon SW6-10; female hexagon IN3-8 (with ball head); Cross-head PH1-4 (with impact cap); cross-head PH1 (short); slotted 4.5-8 (with impact cap); slotted 5.5 (short); TX T10-40
- Univ. brake calliper hook pair



Drawer 5 (striking tool, file, drill assortment)

- Gasket scraper
- Workshop file (10" / round + half-round + flat blunt)
- Brake calliper file
- Metalworker's hammer (400 + 1500 g)
- Soft-faced hammer
- Twist drill (1 - 13mm / 25 pcs)
- Pry bar (300 + 390 mm)
- Flat chisel (125 + 150 + 200 mm)
- Cross chisel flat oval
- Pin punch (3 + 4 + 5 + 6 mm)
- Drift punch
- Centre punch



Drawer 6 (combination spanner assortment)

- Special grip pliers
- Brake calliper brush
- Combination spanner (SW6-32)

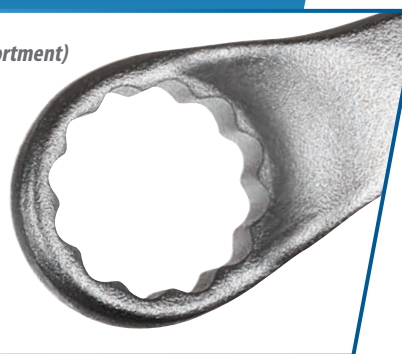

Drawer 7 (screwdriver assortment)

- Open-end spanner with ring ratchet (SW8-19)
- Double ring spanner (SW6-24, TX E6-24)
- Starter block spanner (SW11-17)
- Double ring spanner open (SW8-19)



Drawer 8 (1/2" assortment long)

- Socket spanners hexagon SW10-32 (long); female hexagon IN6-14 (long); TX T27-60 (long)
- Power screwdriver bit with protective sleeve (SW17-22)
- Power screwdriver bit (SW13-27)
- Cable stripping knife
- Universal combination shears



412 parts

Code	No.	Number of drawers	Drawer dimensions	Load-carrying capacity of drawers	Trolley dimensions	Total load carrying capacity (static/mobile)
3421147	KL-4998-400	9 (bottom empty)	W 640 x D 400 mm	40 kg (lowest 60 kg)	H 812 x W 771 x D 478 mm	1,000 kg / 750 kg

1500 H 25-8

SPRAY CAN HOLDER



Made in Austria



- Compatible with conventional Euro square perforation 10 x 38 mm
- Can also be used as a transport box due to removable dividers
- Powder-coated
- With carrying handle
- Inner dimensions are compatible with GEDORE 1500 CT modules
- Front square hole for additional hooks (not included)
- Delivery without tools and accessories

Code	No.	Dimensions W/H/D	Weight
3127907	1500 H 25-8	W 315 mm / H 100 mm / D 165 mm	2.05 kg

1500 H 40

PAPER ROLL HOLDER



Made in Austria



- For paper rolls up to diameter 320 mm and width 320 mm
- Perforation on the side for additional hooks (not included)
- Made of sheet steel
- Colour RAL 9005 black
- Suitable for all tool trolleys/benches with Euro holes 10 x 38 mm
- Delivery without tools and accessories

Code	No.	Dimensions L/ W/ H	Weight
2997754	1500 H 40	L 200 mm / W 350 mm / H 110 mm	1.1 kg

D 20 MOT

VEHICLE TOOL KIT 1/4" FOR MOTORBIKE, 30 PCS.



Made in Germany



- Selected tools with metric dimensions for "first aid" on the motorbike
- In plastic box

30parts

Code	No.	Dimensions L/W/H/D	Square drive	Weight
2190281	D 20 MOT	L 203 mm / W 123 mm / H 38 mm / D 95 mm	6.3 mm	600 g

900 20

LI-MH LED LAMP USB CHARGING PORT

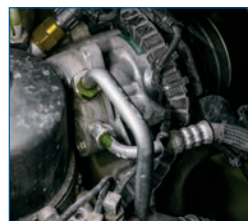
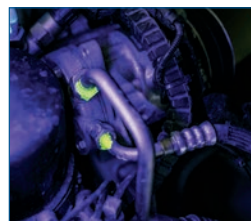

- Versatile LED/UV lamp with a slim design
- Infinitely dimmable, switchable from LED light to UV light blue-violet
- For finding leaks, for example in air conditioning systems, heat pumps, etc.
- Hooks can be folded out on both sides, powerful magnet on the 45° adjustable base
- Powerful mini magnet at the peak for collecting small parts
- Can be charged by the supplied power pack or a USB port

3parts

Code	No.	Length	Brightness	Lamp power	Battery
3108678	900 20	477 mm	620 lumen	16 W	3.350 mAh

R95300139
PENLIGHT



- Compact, slim size
- Protected against the intrusion of small dust particles and splash water
- Good grip even with oily and sweaty hands
- Can also be used with gloves
- Mobile companion for all applications
- Practical clip for attaching to belt, shirt or trouser pocket

Code	No.	Length	Ø	Burn time	Battery type	Battery quantity	Weight
3301758	R95300139	139 mm	15 mm	4 h	AAA	2 pcs	56 g

R95700089
MINI WORK LAMP



- Extremely bright lamp in a very compact format
- Can be used especially in confined spaces
- Magnet provides different holding options in different working areas
- Enables hands-free working
- Mobile companion for all applications
- Practical clip for attaching to belt, shirt or trouser pocket
- Fits in every trouser pocket

Code	No.	Length	Burn time	Battery capacity	Charging time	Weight
3301759	R95700089	89 mm	3 h	600 mAh	2.5 h	35 g

R95600320
INSPECTION LAMP



- Ideal as a work lamp for mobile use in various areas
- 5 switching functions for individually adjustable brightness
- Can be used both as an inspection lamp and as a torch
- Magnet and 180° rotating hook provide different holding options
- Enables flexible and mobile use, as well as hands-free working
- LED can be used both folded in and out

Code	No.	Length	Burn time	Battery capacity	Charging time	Weight
3301760	R95600320	320 mm	12 h	2.500 mAh	4 h	260 g

R95400145
SPOTLIGHT



- Compact, portable spotlight
- Ideal for working in places without power supply
- Rubberised surround, therefore shockproof and splashproof
- 180° rotatable base
- Stand can also be hung up or used as a carrying handle
- Easy alignment of the light
- Power bank function for charging external devices

Code	No.	Width	Burn time	Battery capacity	Charging time	Weight
3301761	R95400145	145 mm	6 h	4.400 mAh	4 h	640 g

COULD YOU SHARE A COFFEE?

Are you already working with our stationary spring compressor or have you perhaps already invested in a mobile axle repair workstation from the **MODULO series**?

Do you still feel unsure about handling our cable harness repair solutions? Or have you been using other **GEDORE** special tools for some time and would like to find out more about new applications?

We will be happy to come to you and carry out an individually tailored application training with you and your team. We will show you how to save time and increase your company's productivity.

For **GEDORE** customers, this service is - except for the coffee - completely free of charge.

You can request your personal appointment via the QR code!



MISSION:
KLANNPOSSIBLE

TIME SAVING, SAFE, WELL THOUGHT OUT TOOLS.



Appointment
request



Your dealer/stamp:

pronax group, s.r.o.

www.pronaxnaradie.sk

pronaxnaradie@gmail.com

A. Popluhár +421 905 483 509

Revolučná 17, 821 04 Bratislava

sídlo: Nádražná 34

900 28 Ivanka pri Dunaji



GEDORE
KLANN EXPERIENCE

SOLUTIONS NEWS + PROMOTION valid
from 01.04.2023 till 30.09.2023.
Only while stocks last.

Delivery without decoration.
Subject to technical changes.

GEDORE Automotive GmbH
Breslauer Straße 41 | 78166 Donaueschingen | GERMANY
Phone +49 +4977183223-0 | info.gam@gedore.com

gedore-automotive.com